

amplifier builder's guide

amplifier builder's guide

Prepared

By the Editors of



PUBLISHED BY

RAD CRAFT PUBLICATIONS, INC

25 west broadway

new york 7, n. y.

C o p y r i g h t , 1 9 4 7
B Y H U G O G E R N S B A C K
A l l R i g h t s R e s e r v e d

F i r s t P r i n t i n g — F e b r u a r y 1 9 4 7
S e c o n d P r i n t i n g — A p r i l 1 9 4 7
T h i r d P r i n t i n g — O c t o b e r 1 9 4 7

P r i n t e d i n U n i t e d S t a t e s o f A m e r i c a

Amplifier Builder's Guide

chapter 1 . . . audio theory and design

Frequency Response—By <i>Robert F. Scott</i>	5
Internal Feedback Problems—By <i>Robert F. Scott</i>	10
Phase Inversion—By <i>Robert F. Scott</i>	13
Resonant Tone Controls—By <i>Robert F. Scott</i>	17
Equalizing the Pickup—By <i>John W. Straede & J. C. Hoadley</i>	21
Volume Expanders—By <i>A. C. Shaney</i>	26
Decibel Level vs. Gain—By <i>S. L. Canterbury</i>	31
A Decibel Nomograph—By <i>Nathaniel Rhita</i>	35

chapter 2 . . . practical audio amplifiers

An 8-Watt PA System—By <i>Andrew Tait</i>	37
16-Watt FM Amplifier—By <i>Herman Yellin</i>	42
10 Watts—Direct Coupled—By <i>A. C. Shaney</i>	45
Transformer-Coupled 6L6's—By <i>Emile J. Rome</i>	51
Wire-Recorder & Amplifier—By <i>Warren M. Davis</i>	55
Dual High-Fidelity System—By <i>Larry Le Kashman</i>	60

preface

THE ORDINARY audio amplifier seems a simple thing compared to r.f. equipment. Yet the average radioman is frequently dismayed at the results when he builds an amplifier. And when it comes to devising an effective equalizer system or volume expander, even the more experienced builder can run into trouble. Audio circuit-design must follow well-established rules. Trouble will result if it doesn't.

In this book we have attempted to clarify some of the basic theory of audio amplifiers so that the reader will be better able to design his own or service commercial audio amplifiers. In addition, a number of practical amplifiers are described. Amateurs should find useful material since practically all of the circuits may be adapted to serve as modulators for low-power transmitters or as drivers for high-power modulators. There is little to interest the amplifier engineer in this book. It was not written for him.

The material is organized in two parts: The first section covers the essential theory and design of audio amplifiers. Phono-pickup, tone-control and expander-compressor circuits have been given special attention, since incorrect design in either will ruin an otherwise satisfactory amplifier. The second section includes a number of proven amplifier circuits which use either resistance-capacity, direct, or transformer coupling, or a combination of the three. The recent entry of wire recorders into the field of sound equipment has not been forgotten—we have included complete information on constructing a steel-wire sound recorder and playback amplifier.

Theory and practical material have been interwoven wherever possible so that the builder may learn from the equipment how and why certain component values are used under specific conditions and what will be the results of varying these values.

While most of the material is not new (it originally appeared in *RADIO-CRAFT* or *RADIO & TELEVISION* magazines), it has been extensively rewritten, revised and corrected. The illustrations have also been revised and corrected where necessary. And, more important, the material has been organized in logical sequence to make a convenient reference book.

FREQUENCY RESPONSE

LET US attempt to throw some light on the theory behind the operation of the lowly speech amplifier found in so many types of electronic equipment: radios, electric phonographs, public address apparatus, electronic pianos and sound-on-film projectors.

The primary purpose of such an amplifier is to properly amplify feeble electrical impulses to a value where they will be able to operate

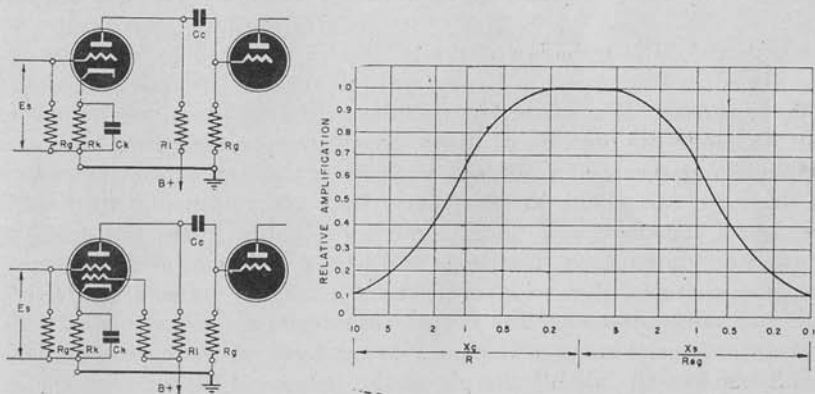

Figs. 1 and 2—Left—Typical resistance-coupled amplifier stages, using triode and pentode. Fig. 3—Right—General response curve of resistance-coupled amplifiers.

headphones, drive power amplifiers or operate metering or recording devices. These very minute voltages may be the output of a microphone, electric eye, phonograph pickup or other voltage-generating device. Hence a speech amplifier is merely a voltage amplifier designed to operate properly over audio frequency ranges.

Speech amplifiers are designed to produce a sufficient amount of voltage amplification without distortion. In order to do this, it is necessary

to select certain tubes and operating conditions as well as coupling methods to satisfy our specifications.

From our knowledge of the different classes of amplification, we realize that the class A amplifier will answer our needs most effectively, for class A amplifiers are able to produce high gain without introducing distortion to the extent where it will become objectionable.

To utilize the output of a vacuum-tube amplifier, the plate of the tube must be connected to the high-voltage supply through some kind of plate load. This load may be inductive or resistive.

Resistance-coupled amplifiers

Resistance-capacitance coupling is employed with triodes as well as pentodes. Figs. 1 and 2 are actual circuit diagrams of single stages of resistance-coupled amplification employing triode and pentode tubes respectively. It will be noticed that there is a resistor in the plate circuit of each tube. This is the plate resistor and is designated by the symbol, R_p . Also attached to the plate is a condenser which has its opposite end attached to the grid resistor and the grid of the following tube. This condenser C_c is called the coupling condenser and serves to transfer the alternating impulses to the grid of the following stage. The voltage passed by the coupling condenser is impressed across the grid resistor, R_g . The voltage drop across the cathode resistor, R_k , serves to make the cathode positive with respect to the grid (or the grid negative with respect to the cathode). The cathode resistor is usually bypassed by a condenser, C_k , placed in the circuit to bypass any alternating voltages around the cathode resistor. This is done so that the only drop in voltage across R_k will be due to the presence of direct current flowing through it.

One characteristic of resistance coupling is the way in which the gain of the stage varies with the frequency. It is a simple matter to place a resistance-coupled network in a circuit between two stages and call it a resistance-coupled stage. This stage will have certain gain and frequency-response characteristics which will differ from any other stage having different values or tubes. The frequency-response characteristics of such a stage are such that it will pass a broad band of frequencies but the amplification will fall off sharply at the lower and higher frequencies. The shape of the response curve of all resistance-coupled amplifiers is the same and for this reason may be called the universal response curve for resistance-coupled amplifiers. This curve is shown in Fig. 3.

Fig. 4 shows the equivalent circuits for the resistance-coupled triode amplifier stage. Fig. 4-a shows that the grid input voltage, E_s , has the same effect upon the changes of plate current as a generator having an output voltage equal to μE_s placed in series with the plate resistance and the plate resistor. Two values of capacitance are seen in these figures which do not actually appear in the amplifier circuit. These capacitances, C_p and C_{g_s} , represent values which we cannot eliminate from the circuit.

C_p is the sum of the capacitance that exists between plate and cathode of the tube plus the capacitance which exists between the wiring around the plate of the tube. C_g is the input capacitance, which is a combination of the effects of the grid-to-cathode capacitance and the grid-to-plate capacitance. The capacitance of circuit wiring at the grid of the following tube may be of such a value as to enter into the reactions of the stage.

As we have seen, the behavior of an amplifier varies with the frequency; therefore its behavior for each frequency range must be studied individually. The behavior of the stage at intermediate frequencies will be discussed first since all other calculations are made with respect to the gain at intermediate frequencies. For a bird's-eye view of the circuit as seen by the intermediate frequencies, look at Fig. 4-b. In this circuit, the coupling condenser has been replaced by an unbroken path. To understand the phenomenon of the missing condenser, let us recall what we know about the action of the condenser in an alternating current circuit.

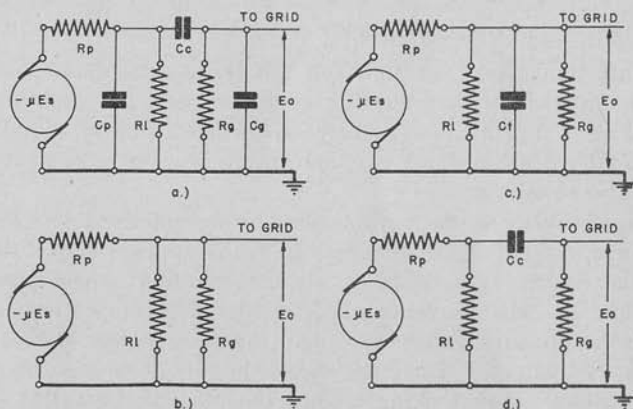

Fig. 4—R-c amplifier circuit elements; (a) shows the equivalent circuit; (b) the effective circuit for intermediate frequencies; (c) for higher frequencies; and (d) for low frequencies.

A condenser does not pass all frequencies with equal ease but gives preference to higher frequencies. Coupling condensers for resistance-coupled stages are selected to have very little reactance or opposition to the flow of alternating currents in the intermediate range.

Let us take a signal covering all of the audio range and having a voltage equal to E_s and place it upon the grid of our amplifier tube. The tube will amplify to a value μE_s . This is the value of the signal when it appears across the plate resistor, R_l . The middle or intermediate range will see a clear path over to the grid of the following stage. Therefore we may consider the grid resistors, R_g , to be in parallel with R_l . This will reduce the effective resistance of both resistors. (The law of parallel resistors.)

In this case, the resultant resistance of R_l and R_g in parallel acts as

the plate load of the tube. Since this resultant resistance is smaller than either one of these values regarded separately, the output voltage will be less than would appear across R_1 if it were not coupled to the grid circuit of the following stage. For this reason, it is desirable to have the values of R_1 and R_g as large as practical. The value of R_1 cannot be increased beyond a specific value because of the direct current losses which would appear across it, making it necessary to employ unusually high values of plate supply voltages. The resistance of R_g should be made as high as permissible. The amplification in the intermediate range of frequencies is given by the following equation:

$$\text{Gain at intermediate frequencies} = \frac{E_o}{E_s} = \mu \frac{R_1}{R_1 + R_p} \frac{R_1}{R_1 \times R_g}, \text{ where } \mu =$$

amplification factor of the tube and $R_1 = \frac{R_1 \times R_g}{R_1 + R_g} =$ resistance

formed by R_1 and R_g in parallel.

It is unfortunate that the high and low frequencies cannot see a clear path, unhampered by the coupling condenser and the shunting capacitances, as seen by the intermediate frequencies. For it would then be possible to have a resistance-coupled amplifier with a straight-line frequency-response curve.

Fig. 4-c is similar to the path as seen by the intermediate frequencies, but we have a shunting capacitance C_t which appears across the output side of the figure. This value, C_t , is the resultant capacitance formed from C_p and C_g . The reactance of C_t at high frequencies is low enough to reduce the effective value of R_1 and therefore reduce the voltage developed at the output. This figure shows the circuit as seen by the high-frequency signal when looking toward the grid of the following stage.

To calculate the degree of amplification at high frequencies, it is necessary to consider the shunting effect of C_t ; all calculations will be made by comparison with the gain for the intermediate frequencies.

Gain at high frequencies

The equation for this calculation is: $\frac{\text{Gain at high frequencies}}{\text{Gain at intermediate freq.}} =$

$$\frac{1}{\sqrt{1 + (R_{eq}/X_{ct})^2}}, \text{ where } R_{eq} = \text{equivalent resistance formed by}$$

plate resistance, plate-load resistance, and grid resistance in parallel

$$\left(\frac{1}{R_{eq}} = \frac{1}{R_p} + \frac{1}{R_1} + \frac{1}{R_g} \right).$$

$X_{ct} =$ reactance of total shunting capacitance, C_t $\left(\frac{1}{6.2832 \times f \times C_t} \right).$

($f =$ frequency in cycles and $C_t =$ capacitance in farads).

From these equations it is evident that the falling off of the high frequencies is due to the presence of the shunting capacitance and the extent of the drop in amplification level is always determined by the ratio of shunt reactance of the shunting capacitance to the equivalent resistance. The extent of the decrease in gain at high frequencies is emphasized by the fact that when the gain has fallen 29.3 percent from its value at intermediate frequencies, the reactance of C_t is then equal to the resistance formed by R_p , R_1 and R_g in parallel.

Value of coupling condenser limits low frequencies

The coupling network, as seen by low frequencies (Fig. 4-d) reveals that the shunting capacitances do not enter into the calculations but the coupling condenser C_c has quite a bit to say about the frequency-response curve. The reactance of this condenser at low frequencies becomes so large that this value will be effectively in series with the value of R_g and the consequent combination will form a voltage divider with the grid of the following stage connected at the tap between the reactance and grid resistor.

All calculations of low-frequency gain must be made with reference to the gain at intermediate frequencies. The following equation applies for these calculations:

$$\frac{\text{Gain at low frequencies}}{\text{Gain at intermediate frequencies}} = \frac{1}{\sqrt{1 + (X_{cc}/R)^2}}, \text{ where } X_{cc} = \text{reactance of coupling condenser } \left(\frac{1}{6.2832 \times f \times C_c} \right) \text{ and } R = \text{resistance formed by the combination of the grid resistor in series with the plate and load resistances in parallel } \left(\frac{R_1 \times R_p}{R_1 + R_p} \right).$$

(f = frequency in cycles and C_c = capacitance of coupling condenser in farads).

The observations formed from this equation may be stated as follows: "The degree to which the signal falls off at low frequencies is dictated by the ratio of the reactance of the coupling condenser to the resistance formed by the combination of the grid-leak resistance in series with the plate resistance and plate load resistance in parallel."

Internal Feedback Problems

THE DEGREE to which the falling off at low frequencies takes place in a resistance-coupled amplifier may be seen by feeding a voltage of fixed amplitude but varying frequency through the coupling condenser. At the *critical* frequency, which makes the reactance of the condenser equal to the resistance of R_g in series with R_p and R_l in parallel, the voltage at the *output* will have only 70.7 percent of the amplitude at intermediate frequencies. This frequency is known as *the nominal low-frequency cut-off* and is designated as f_1 . It will be noted from the universal amplification curve (Fig. 3) that signals having frequencies equal to multiples and submultiples of f_1 have definite relationships to the intermediate-frequency gain. This is because the reactance varies inversely as the frequency. It is therefore conclusive that the voltage drop across the coupling condenser is inversely proportional to the frequency. It may be well to mention that this curve applies to all resistance-coupled amplifiers regardless of the frequencies being passed; thus this curve may be used to compute response curves for audio or video amplifiers.

There is also a point on the curve where the high-frequency gain drops to 70.7 percent of the intermediate-frequency value. This frequency is called *the nominal high-frequency cut-off*. It is that frequency which makes the reactance of the shunting capacitances equal to the resistance formed by the parallel combination of the plate resistance, plate-load resistance and the grid-leak resistance. It will be seen from the curve that, as with the low frequencies, the multiple and submultiple frequencies of the nominal high-frequency cut-off frequency have the same relationships as in the low-frequency ranges.

If you wish to prepare your own universal curve for use on specific circuits, the nominal cut-off frequencies may be calculated from the equations below.

$$\text{Low-frequency cut-off} = 1/6.28 \times C_c \times R$$

$$\text{High-frequency cut-off} = 1/6.28 \times C_t \times R_{eq}$$

Throughout most of this discussion we have taken the triode tube for most of our calculations. It should be noted that the same equations may be applied to the pentode tube with the exception of the equation for

finding the gain of a pentode stage at intermediate frequencies. The equation which applies in this instance is:

$$\text{Gain} = \frac{E_o}{E_s} = G_m \times R_{eq}, \text{ where } R_{eq} = \text{equivalent resistance formed}$$

by plate resistance, plate-load resistance and grid resistance in parallel.

Interesting to note is the fact that when a given value of coupling condenser has been selected, the grid resistor for good low-frequency response should be as large as practical; while a low value of grid resistor is most desirable for good high-frequency response. This apparent contradiction may be overcome by selecting the circuit constants so that the grid resistor is small enough to counteract the shunting effect of the interelectrode and shunting capacitances, while the coupling condenser is made large enough to pass the lowest frequency without noticeable attenuation.

The input capacitances of a tube will depend upon the gain of that tube in a particular circuit. The total shunting input capacitance is equal to:

$$C_{\text{Input}} = C_{gc} + (M + 1) C_{gp}, \text{ where}$$

C_{gc} = grid-to-cathode capacitance,

C_{gp} = grid-to-plate capacitance and

M = voltage gain of the stage. To

the input shunting capacitances should be added the output capacitances of the tube preceding the

resistance network, found from the tube manual, and 7 micromicro-

farads for stray capacitances.

Another factor which may make its presence felt in the amplifier is

insufficient value of cathode bypass condenser, C_k . It makes its presence

felt by causing an undue reduction in the low-frequency response. It is

this condenser which is used to bypass the audio voltages present on the

cathode around the biasing resistor. If the reactance of C_k is high when

compared to the value of R_k , at the lowest frequency, there will be an

additional voltage drop across R_k due to the presence of the audio

voltage appearing across it. This voltage has the effect of reducing the

amplification of the low frequencies. This unnecessary reduction of the

bass notes may be prevented by employing a cathode bypass condenser

sufficiently large to have a very small reactance at the lowest frequencies

to be amplified.

Those who have the occasion to build or use a high-gain amplifier will

at some time run into internal feedback, which will be manifested in

the form of uncontrolled oscillations and motorboating, caused by re-

generation within the circuits. This problem is most common when a

common plate-voltage supply is used. The final stage of the amplifier

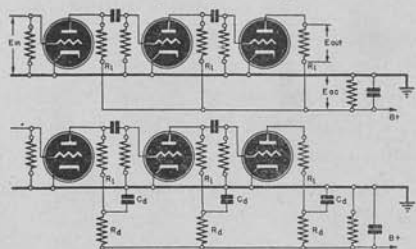

Fig. 5—top—Internal impedance causes feedback. Fig. 6—bottom—Isolating filters eliminate coupling.

will develop an alternating-current voltage between the plate of the tube and the ground. From Fig. 5 we see that when the voltage is measured from plate to ground, a portion of this voltage appears across the output of the power supply. The reason for this voltage drop is that the filter condensers of the power supply seldom have sufficient capacity to have negligible reactance. Therefore the alternating voltage will also appear across the plate supply of the other tubes in the amplifier. In each case when the alternating voltage is placed on the plate of a tube, it is transferred to the grid of the following stage. Thus internal feedback is generated within the amplifier. Perhaps a better understanding of this phenomenon will be gained from a study of the figure.

Suppression of regeneration

Suppression of regeneration in the amplifier stages may be accomplished by inserting an additional resistor in series with the supply voltage and the plate loading resistor. A high capacitance is placed between the junction of the two resistors and the ground. The feedback voltage from the last audio stage will appear across the resistor which we have added to the circuit. This resistor is known as the decoupling resistor. The condenser serves two purposes. First, it bypasses the unwanted voltage to ground. Second, it serves to furnish additional filtering for the plate voltage of each stage, thus reducing residual hum which may be present due to insufficient filtering in the power supply. See Fig. 6.

The value of the decoupling resistor R_d may be determined from the equation:

$$R_d = \frac{E_d}{I_p} \times 1,000, \text{ where } R_d = \text{decoupling resistor (in ohms), } I_p =$$

total plate current (in milliamperes) and $E_d =$ maximum allowable voltage drop across R_d .

The value of the decoupling condenser C_d may be determined by the general rule: *The ohmic impedance of the condenser (at the lowest frequency being amplified) should not be more than 1/5 the value of the decoupling resistor.* In audio work it is safe to assume that the capacitive reactance of the condenser is roughly equal to its impedance at a given frequency.

When selecting the tube line-up for your speech amplifier, it is common to employ a pentode tube in the first stage, due to the very low input voltage which is often encountered there. It is seldom necessary to use two pentode stages in cascade because such high amplification concentrated in the first stages of an amplifier will often cause dynamic instability. If you use pentodes, remember this important point: See that the screen-grid voltage is kept at the correct value. This voltage may be obtained from a voltage divider across the power-supply output. The screen should be sufficiently bypassed to keep it always at zero potential with respect to audio voltages.

PHASE INVERSION

PUSH-PULL stages are often used in a speech amplifier either to supply the necessary voltage to drive an output stage or to reduce certain types of distortion. One of the simplest methods of producing the 180-degree out-of-phase voltage for the grids of the push-pull stage is to employ a transformer with a split secondary winding. This is highly efficient but does not always possess desirable frequency-response characteristics. A transformer with good response characteristics is costly, and inclined to pick up hum from the magnetic fields around the power transformer and filter chokes.

Another method, *phase inversion*, may be used.

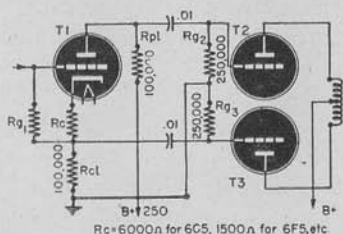

Rc = 6000Ω for 6C5, 1500Ω for 6F5, etc.

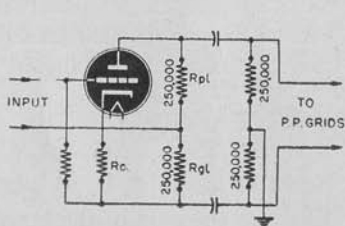

Fig. 7—left—A cathode-loaded or "Kangaroo" inverter. Fig. 8—right—Equivalent circuit for figure 7.

The phase inverter is a simple, economical method of replacing the push-pull interstage transformer. The fidelity of this circuit is often better than can be obtained from the most costly of audio transformers. It is common to employ resistance coupling in a speech amplifier and phase inversion enables it to be applied throughout the entire amplifier. One possible disadvantage of phase inversion is that in most of the circuits the inverter tube does not furnish much gain. This is due to the use of degeneration.

The first type of inverter circuit to be discussed is the *cathode-loaded* type. Let us picture the average single-ended resistance-coupled amplifier

stage. In this case the gain of the stage is equal to $\mu \frac{R_1}{R_1 + R_p}$

and the voltage applied to the following grid is 180 degrees out of phase with the input voltage of the first stage. This scheme is suitable for exciting a following single-ended stage but could not possibly be used to excite a push-pull stage.

Suppose we should split the output load of our amplifier tube so that

half of the load would appear in the cathode of the tube. Will it work? Certainly it will. The output voltage will be equal to the plate current change times the value of the load resistor. Let us look at Fig. 7 where we see one-half of the tube load inserted in the cathode circuit between the cathode-biasing resistor and the ground. This load resistor we choose to call R_{c1} while we call the load in the plate circuit R_{p1} .

The grid leak is returned to the junction of the grid-bias resistor and the cathode-loading resistor. This is done to maintain proper potential difference between the grid and cathode. The grid-circuit resistance is the sum of R_{g1} and R_{c1} . Hence, R_{c1} is common to both the input and output of the inverter tube. The output voltage is proportional to the plate-current changes and since it is necessary to supply equal voltages to both grids of the push-pull stage the values of the loading resistors should be equal.

The equivalent circuit for the cathode-loaded inverter is shown in Fig. 8. Since a portion of the load appears in both the input and output circuits degenerative feedback is introduced into the circuit, with a reduction in the gain and an increase in the effective plate resistance. The gain can no longer be calculated from the equation for resistance-coupled amplifiers but must be computed from the equation:

$$\text{Gain (with feedback)} = \frac{2 \mu R}{R (\mu + 2) + R_p}, \text{ where } \mu = \text{amplification factor of the tube, } R_p = \text{plate resistance and } R = R_{p1} = R_{c1}.$$

In this case the gain of the inverter will never exceed 2. This is because the gain with feedback varies inversely with the amount of feedback voltage. It has been established that when the percentage of feedback voltage is large; the overall gain of the stage will be independent of the amplification factor of the tube.

Advantage of inverse feedback

Several types of distortion are likely to be generated within the vacuum-tube amplifier stage. One advantage of inverse feedback is that it tends to reduce the percentage of distortion present. Let us assume that D represents the percentage of distortion present in a stage having a voltage gain of A without feedback. Now if B is taken as the feedback factor, when feedback is introduced into the circuit, we find that although distortion is still present in the circuit it will have a value of D' . This new value is found to be equal to $D/1 + BA$.

This shows that the reduction in distortion is dependent upon the factor BA . Since, in the cathode-loaded inverter, the feedback factor is a fixed value of 50 percent, the only other possible method of decreasing the distortion is by increasing the value of A or by using a tube of higher gain. (Proper application of feedback reduces distortion in the same proportion as the amplifier gain is reduced.) Feedback not only improves

response by a reduction of distortion but is equally effective in reducing the hum which may be picked up by the stage to which the feedback is applied.

We have mentioned that the gain of such a stage never exceeds 2. This factor is taken from the ratio of the input voltage to the voltage measured across the grids of the push-pull tubes. Assuming a gain of 1.9 for the inverter, the gain from the grid of the inverter to either of the push-pull grids will be only .95.

Although the gain of this type of inverter is comparatively low, the voltage available at the output is quite capable of exciting almost any combination of output tubes. The maximum grid-to-grid voltage is equal to approximately 20 percent of the plate supply voltage.

A circuit for phase inversion which has been popular for a number of years is the *tapped output inverter*. This is also one of the most criticized. Perhaps this criticism is due to a misunderstanding of the circuit. Two tubes are employed to give the proper phase changing and amplification.

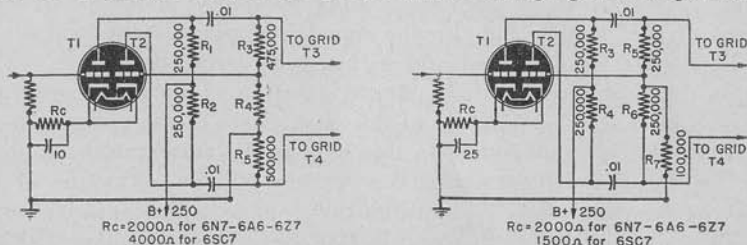

Fig. 9—left—An efficient amplifier-inverter stage. Fig. 10—right—The so-called "self-balanced" inverter.

These tubes may be identical triodes or one of the dual-triode types such as the 6Z7, 6N7, 6SN7, or the 6SC7. The latter tube is especially designed for phase-inverter service. The circuit is illustrated in Fig. 9 where T_1 and T_2 may be separate triodes or the two sections of a dual triode.

There is practically no degeneration in this circuit. The gain is equal to $\mu \times R_1 / (R_1 + R_p)$ so the use of a high-mu triode will result in a higher overall gain for the inverter stage.

T_1 operates as a conventional resistance-coupled amplifier working into the grid of T_3 . The output of T_1 appears across the grid resistor of T_3 , which is composed of R_3 and R_4 in series. The grid of T_2 is tapped to this network at the junction of R_3 and R_4 . A voltage tapped at any place along this resistor is of the same phase as the voltage on the grid of T_3 and is proportional to the grid voltage. Since it is normal for T_1 and T_2 to be identical tubes their gains will be equal and it is necessary for the input voltage to both tubes to be equal in order that their outputs will be equal. We may consider the voltage input to T_1 as being E_s . It is then necessary for the input of T_2 to be of the same value. This value may be obtained by adjusting the

relationship between R_3 and R_4 . If each of these tubes has a voltage gain of 20, the voltage across R_3 - R_4 will be equal to $20E_s$. The value of R_4 would be computed from the equation $R_4 = R_5/20$.

The resistors chosen for R_3 , R_4 and R_5 should be as near the correct values as possible. The adjustment of R_4 should be made under operating conditions. This is done by connecting the push-pull tubes in *push-push*, i.e., the grids in push-pull and the plates in parallel; with the amplifier working at full gain there should be no noticeable audio output. This is so because when the grids are fed with equal voltages 180 degrees out of phase there will be zero change in the plate current, hence, no signal. This circuit will serve quite efficiently if it is correctly balanced. Since its gain is high, it is often used in portable musical-instrument amplifiers.

Self-balancing inverter

Still another circuit employing two tubes in the phase-inverter setup is known by several names, such as *floating paraphase* and *self-balancing inverter*. In this circuit, Fig. 10, the signal is applied to the grid of T_1 . This signal will be amplified and will appear across R_5 and R_7 which serve as the grid resistor of T_3 . At the junction of these two resistors, there will be a voltage which is of the same phase as the voltage on the grid of T_3 and is proportional to this voltage. R_7 serves as the grid resistor for T_2 . The voltage across this resistor will be a fraction of the voltage on the grid of T_3 . T_2 amplifies this voltage, which appears across the grid resistor of T_4 , R_6 - R_7 , and is 180 degrees out of phase with the voltage on T_3 .

R_7 is common to both the input and output circuits of T_2 . Since R_7 has the out of phase voltages from T_1 and T_2 flowing through it, the voltage drop will be equal to the algebraic sum of the two voltages appearing across it. It is this voltage difference that is impressed upon the grid of T_2 . Due to degeneration caused by the presence of R_7 in both input and output circuits of T_2 , the voltage ratio of the push-pull grids will never be equal to unity but the slight unbalance in the voltages upon the grids of push-pull output tubes may be tolerable if the difference does not exceed 10 percent. One particular advantage of this circuit is that the slight variations which may result from a mismatch of tubes or slight deviation of the values of the resistors will be compensated by the circuit; hence, it is called self balancing.

The degenerative effect in T_2 will serve to reduce distortion and hum just as in the cathode-loaded inverter.

The values for the resistors and condensers used in these circuits may be taken from any table of values for resistance-coupled amplifiers. The correct operation of these circuits does not demand any expensive or hard-to-get equipment but may be adjusted with the minimum of equipment that is usually found on the work bench of any serviceman or even the moderately equipped home experimenter.

RESONANT TONE CONTROLS

THE HUMAN ear responds differently to sounds of different frequencies and intensities, and attempts to compensate for losses in high- and low-frequency gain which are common in most types of audio amplifiers. It is necessary, for satisfactory listening, to compensate for these deficiencies of the ear and of electronic devices. The frequency-response characteristics of an amplifier may be altered to suit the most critical listener. Any method used to control the frequency response of an amplifier is commonly called a tone control. It is often referred to as *tone compensation* or *equalization*.

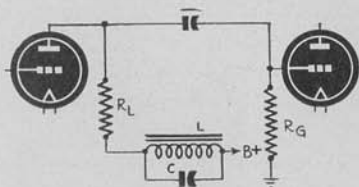
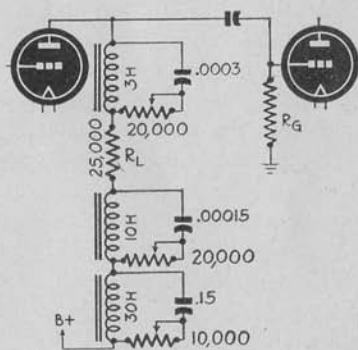

Fig. 11—above—Connection of parallel-tuned network in amplifier plate circuit, to increase amplification at the resonant frequency of the network.

Fig. 12—right—Multi-tuned circuit for varying gain at low, medium and high a.f.



Two distinct types of tone controls are used in audio amplifying systems. These types are *non-resonant* and *resonant* systems.

Non-resonant circuits are illustrated in the section on phonograph pickup equalization. It may be well to remember that the non-resonant circuit may be made to boost or suppress some portion of the audio spectrum *but in no instance of boosting is it possible to exceed the value of amplification at the middle frequencies*.

We are aware that when all factors are constant, the amplification of a vacuum-tube amplifier varies directly as its plate-load impedance. We can see that it is desirable to have some scheme by which the impedance

may be made to change with the frequency. This may be accomplished by the use of tuned circuits properly placed in the plate load.

A parallel- or series-tuned circuit may be made to accept or reject the frequency to which it is resonant. It is this factor which makes it applicable to tone control circuits. Unlike non-resonant circuits, it is possible to exceed the gain at the middle frequencies if it is desirable.

In the resonant circuits, there are three constants for each particular

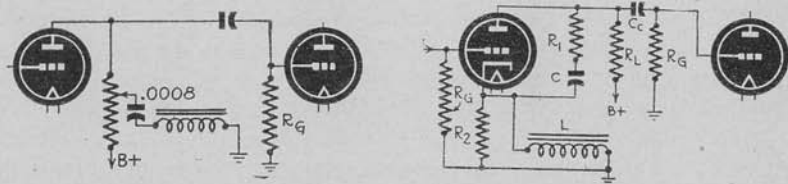

Fig. 13—left—Series-resonant network applied to plate load resistor of a tube to compensate for loss of high and low frequencies at low volume. Fig. 14—right—Series-tuned circuit may be combined with inverse feedback for tone control.

frequency. These are capacitance, inductance and resistance. The latter is equal to the d.c. resistance at audio and low radio frequencies but increases far above the d.c. value at higher radio frequencies. The inductance and leads of the circuit will be the only factors to introduce appreciable resistance in the circuit.

Parallel and series circuits have characteristics which are opposite but each has specific advantages for certain applications.

The *series-tuned* circuit is characterized by maximum current and minimum impedance at the resonant frequency. The magnitude of the current in the circuit is controlled by the value of the resistance.

The *parallel-tuned* circuit presents maximum impedance and voltage at the specific frequency to which it is resonant. This type of circuit is most commonly encountered in practice and will be discussed first, since it is probably the most easily recognized of the resonant circuits.

The voltage across such circuits is proportional to the impedance ($E = IZ$), hence it is desirable to have a high ratio of inductance to capacitance (high L and low C).

Fig. 11 illustrates how a parallel-tuned network may be connected in the plate circuit of an amplifier tube to increase the amplification at the resonant frequency of the network. At a frequency which makes the reactances of L and C equal, the impedance will be very high. Since this impedance is in series with the plate load resistor, R_1 , the total plate load impedance may be considered as equal to $R_1 + \frac{1}{\sqrt{R^2 + (X_1 - X_c)^2}}$,

where $X_1 = 6.28 \times f \times L$ and $X_c = \frac{1}{6.28 \times f \times C}$. ($6.28 = 2\pi$).

($R =$ D.c. resistance of the inductance)

At frequencies removed from resonance, the effective impedance of the

network is reduced to such an extent that the plate load impedance becomes equal to R_1 . The value of R determines the sharpness and magnitude of the resonant peak voltage.

If R_1 is considerably smaller than R_g and R_p in parallel ($\frac{R_g \times R_p}{R_g + R_p}$) the

increase in amplification at resonance will be appreciable, hence this circuit is most efficient when applied to high- μ triodes and pentodes.

Fig. 12 shows a circuit which may be employed to gain complete control of the frequency-response characteristics of an amplifier stage. Thus it is possible to compensate for deficiencies in the response of a mike, pickup or speaker or for specific unwanted acoustic conditions. This circuit has been found to give a wider range of boosting and control than is possible with some of the commercial types of tuned network controls.

This circuit is fundamentally the same as Fig. 11. In the circuit, there are three tuned networks. Two of these networks resonate on the high-frequency end of the audio range and the amplification at these frequencies is fairly constant up to 15,000 cycles. The remaining network is tuned to a frequency of 60 cycles and, when a low-Q choke is employed, the curve will be sufficiently broad to bring up the response at frequencies as low as 15 cycles. The values of the constants in these circuits are shown in the figures. The sharpness of response may be controlled by the presence of variable resistances in each of the tank circuits. For maximum boosting of the resonant frequency, the impedance of the circuit must be higher than the value of the plate-load resistor.

The series-tuned network consists of a condenser and inductance connected in series. The impedance is at its minimum value at resonance.

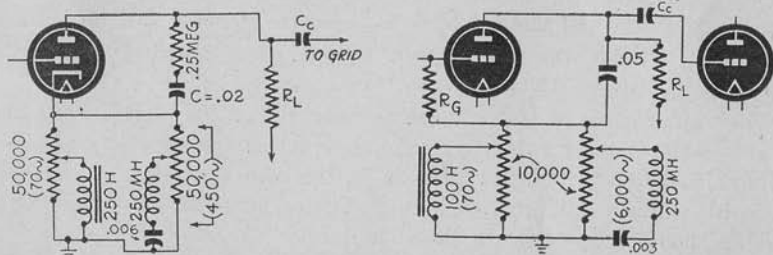

Figs. 15 and 16—Applications of the fundamental circuit of Fig. 14. The first circuit functions similarly to that in Fig. 14. Circuit in Fig. 16 is somewhat similar in its operation. Here the tuned circuits are placed in the grid lead of the amplifier.

As in the parallel-tuned circuit, the sharpness of the circuit depends on the network's Q . Such a circuit may be applied to the plate-load resistor of a tube to compensate for the apparent low- and high-frequency losses when the radio or amplifier is being operated at low volume. An application of this principle is shown in Fig. 13. The plate-load resistor is in

the form of a potentiometer with its movable arm connected to the series-tuned network. This is tuned to the middle of the audio range, 1,000 cycles, and due to attenuation at this frequency, the highs and lows will be apparently boosted. The degree of attenuation will depend upon the setting of the arm on the plate resistor.

The series-tuned circuit may also be combined with inverse feedback for tone control which was shown in the fundamental circuit in Fig. 14. We know that if a portion of the output voltage of an amplifier stage is fed back to the input in proper phase relationship, the original signal voltage will be reduced at the frequency of the feedback voltage. In Fig. 14, the feedback voltage is taken from the plate circuit and fed back to the cathode circuit. The amount of feedback voltage is limited by the value of R_1 . By inserting a tuned network in the feedback line we will have a high impedance at all frequencies removed from resonance. This causes the non-resonant frequencies to appear as a voltage drop across the impedance and R_2 in parallel. This voltage is in opposition to the signal voltage and the gain is reduced. At the resonant frequency, the impedance is low and the voltage is bypassed to ground. There is no degenerative action; and the gain is boosted at the resonant frequency.

Combining series-tuned circuit with inverse feedback

Figs. 15 and 16 are applications of the fundamental circuit. The former circuit functions in the same manner as discussed for Fig. 14. Fig. 16 is somewhat similar in its operation. In this case the tuned circuits are placed in the grid lead of one of the amplifier stages. All frequencies which are removed from the resonant frequency will have their amplification reduced through the medium of inverse feedback. At the resonant frequency of the tuned networks, the impedance will become very low and the voltage fed back at these frequencies will be bypassed to ground without any appreciable voltage drop which would tend to neutralize the input signal voltage.

When attempting to apply these circuits, it may be somewhat difficult to obtain the correct value of inductance called for by the diagram or from calculations. If this happens to be the case, it is well to remember that old audio transformers, high-resistance speaker fields and small a.c.-d.c. chokes will often do excellent jobs.

It is difficult to even estimate the inductance of a coil or choke without employing laboratory equipment which is unavailable to the average experimenter, but in these circuits, the cut-and-try method will give excellent results if the builder has a little patience. Many headaches and hours spent computing reactances, resonant frequencies and other values may be saved if the builder has available a Reactance Slide Rule.

EQUALIZING THE PICKUP

IN THE reproduction of any record we must take into account the various recording characteristics and compensate the pickup accordingly. Standard phonograph records are recorded with a "modified" velocity characteristic. Amplitude of the cutting stylus is held constant from the lower frequency limit (around 50 cycles) to between 300 and 800 cycles, and modified constant velocity above this crossover frequency provides a five- to ten-decibel boost at 8,000 cycles. See Fig. 17. As it shows, there is a falling-off at the low-frequency end of the audio

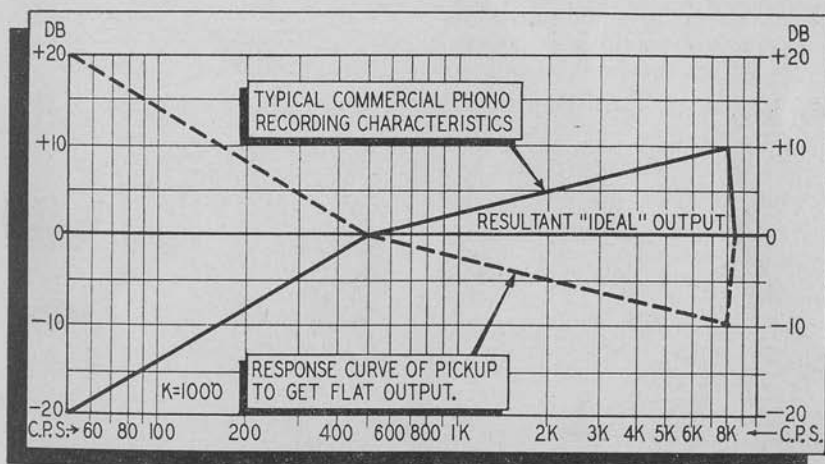

Fig. 17—Recording and playback characteristics balanced to produce flat output.

spectrum. If the low-frequency amplitude were not restricted, either overcutting would result or the level of the high frequencies would be below the noise level.

This recording characteristic is used for the following reasons:

1. Due to widespread use of crystal type pickups, the manufacturers of records insert high-frequency boost to reduce the compensation neces-

sary to flatten the playback equipment's response. This boost effects a considerable improvement in signal-to-noise ratio.

2. Most low-priced record players have serious attenuation of the higher frequencies and no means for compensation.

If modified constant-velocity records (without treble boost) are played back with a *magnetic* pickup the output will be flat with decreasing frequency down to the crossover frequency where constant amplitude begins. Since the magnetic pickup requires successively greater stylus

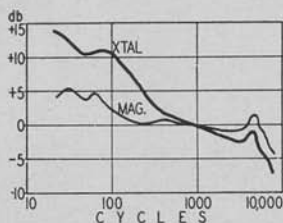
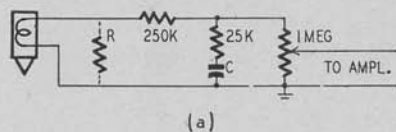
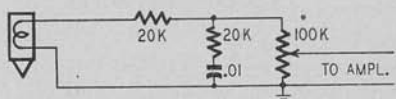

Fig. 18—above—Frequency-response curves for cheap crystal and magnetic pickups.

Fig. 19—right—Compensating magnetic pickups. a—bass boosting for pickup with 20-cycle resonance ($C = .015 \mu\text{f}$ for U.S. records, $.03 \mu\text{f}$ for British. Value of R is manufacturer's recommendation). b—Bass boosting for pickup with 60-cycle peak. c—Another equalizing circuit. C (value $.002$ to $.02 \mu\text{f}$) reduces treble response.



(a)



(b)

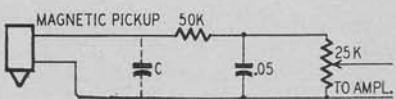

(c)

motion at the low frequencies to maintain its output flat, and since the amplitude is held constant below the crossover frequency (300 to 800 cycles) we must provide an equalizer to compensate for this condition. And, since practically all commercial records made in the last six or seven years have a treble boost, the magnetic pickup must be further compensated to *reduce* its high-frequency response. Otherwise response from commercial records will be excessively brilliant.

A crystal pickup has a *constant-amplitude* characteristic. Its output voltage is a direct function of stylus motion independent of frequency up to its high-frequency cut-off point. For constant velocity recording (without treble boost) above the crossover frequency we would have to compensate for the decrease in stylus amplitude with frequency. This is in the order of six db per octave above the crossover frequency. To compensate the crystal pickup for this would require considerable boost at 7,000 cycles. However, commercial records insert treble boost at a rate of from two to about five db per octave above the crossover frequency, depending on the record. Thus for some records no high-frequency equalization is required and for others only a small amount.

Any pickup contains *two resonant frequencies*; the lower or *bass resonance* due to the pickup head vibrating to and fro, and the upper or

needle resonance due to the armature vibrating against the needle-tip (needles are not perfectly rigid).

The lower resonance is sometimes used—especially in cheap pickups—to partially compensate for the bass cut in recording, but the upper resonance is just plain nuisance as it occurs at a very audible frequency.

Scratch and surface noise occurs at all frequencies, high and low, but mostly around the resonant frequencies.

A pickup filter is necessary then for three reasons: To compensate for lack of bass, to reduce excessive high-frequency response and to reduce the response around the resonant frequencies.

In Fig. 18, the frequency responses of a typical average-quality magnetic pickup and an average crystal pickup are shown. It will be noticed that while in both cases there is a peak at about 4,500 cycles, because both employ steel needles, the crystal pickup has a rising bass characteristic in addition to bass resonance.

Overall frequency characteristics do not tell the whole story. Although a resonance peak may be levelled out, there is still no compensation for the longer time a note (recorded or "scratch") is played if it occurs at that resonant frequency. When a sound is heard for a fairly short time, its audibility is largely proportional to the product of its intensity and its duration, so a partial compensation for excessive duration can be achieved by *overreduction* in response at the peaks.

In designing correction filters, it is necessary to know just what is being aimed at, otherwise the filter is apt to be a flop. A simple but correctly designed filter consisting of only two or three elements can easily give results superior to those from an elaborate but badly designed one.

The position of a filter affects its action. If connected directly after the pickup, reactive elements in the pickup must be considered. If connected after the first tube, the type of tube must be taken into account. In simpler amplifiers, some compensation can be done in the output stage.

Two main types of correction circuits will be considered:

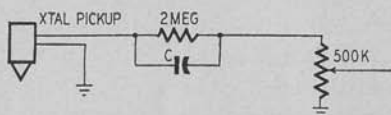
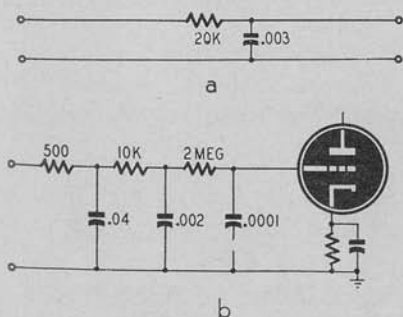

Fig. 21—above—Equalizer circuit for crystal pickup.

Fig. 20—left—Two circuits for cutting the highs.

1—Resistance-capacity circuits (these are probably the most interesting to the amplifier enthusiast and the easiest to build).

2—Circuits in which compensation is made by varying the amount of negative feedback.

Tuned circuits for equalization are discussed in the preceding section.

Two main types of circuits are employed, those that give an *apparent* bass boost by attenuating all the higher frequencies to a lower but finite value and those that progressively reduce the highs, approaching zero response as the frequency increases.

The first type can be designed to give a "boost" of any desired rate over any frequency range, but the amounts of boost cannot approach infinity as the loss at high frequencies due to the filter is at least equal to the bass boost produced at very low frequencies. If the pickup has a very low bass resonant frequency, say around 20 cycles, full compensation is needed and the filter must provide a boost of around 6 db per octave. On the other hand, if the pickup head is fairly light and the needle very stiff and difficult to deflect, the bass resonant frequency will be well inside the audible region and little compensation is required. Magnetic pickup circuits for both these conditions are shown in Fig. 19.

Attenuating the highs

Now what about the high-frequency end of the spectrum? This end is never attenuated in recording and is usually boosted, so the problem is how to attenuate the highs to a reasonable value. If the high boost is progressive (increasing with frequency), a simple one-section filter such as is shown in Fig. 19-c may meet the case. Condenser C cuts treble response. Value is from .002 to .02 μ f. Or the one-section filter of Fig. 20-a may be used. The resistance may be the plate resistance of the first tube in the amplifier—in which case only the condenser is used—or the filter as shown may be connected directly after a high-impedance magnetic pickup. Sometimes when the pickup is a really good one with a high needle resonance frequency, a multi-section filter may be used to give a sharp cut-off just below the unwanted resonance. The circuit of such a filter is shown in Fig. 20-b, the constants being suitable for a 500-ohm or medium impedance job.

No account is given of low-pass or band-pass circuits because—although restriction of unnecessary frequency response is sometimes helpful in eliminating background noise and in scratch reduction—circuits are difficult to adjust and not at all suitable for the average amplifier enthusiast.

It is very rarely that a boost is required in reproducing the upper highs around 5,000 cycles, but if required, the circuits of Fig. 19 may be used with the series resistor bridged by a small capacity such as a .002- μ f condenser.

As explained previously, a *crystal* pickup seldom requires bass boosting. The customary method of compensating crystal pickups for commercial records is shown in Fig. 21. Reducing the value of C will reduce the amount of treble boost. For maximum boost C should be about .002

$\mu\text{f.}$ When playing records having considerable treble boost, C should be reduced in value to as low as 50 $\mu\text{f.}$

A simple way of obtaining a boost or accentuation at low or high frequencies is to provide a large degree of negative or inverse feedback and to reduce this feedback at the frequencies to be boosted. Condensers are employed to give this effect. A series condenser restricts the low-frequency feedback, giving a bass boost; a condenser connected between the inverse feedback line and ground reduces the feedback at the higher frequencies, giving a treble boost. In receiver design, the high frequencies are attenuated due to sideband cutting and considerable compensation is necessary, but in the design of audio amplifiers to follow pickups the problems are different. *If* (mind the *if*) any high-frequency boost is needed, it should be limited in value and should occur only in a frequency band well away from the top resonant frequency. If a shunt condenser is employed in the negative feedback network, such a condenser should be very small. Typical values are given in Fig. 22.

More low-frequency compensation is required after a pickup than after a radio tuner, so the series condenser employed to reduce low-frequency feedback will be smaller. The bass boost is sometimes greater than anticipated owing to the feedback becoming positive at very low frequencies. Take care that there is not too much phase change in the amplifier, otherwise excessive feedback may take place at low or high frequencies, resulting in motorboating or a high-pitched whistle or hiss.

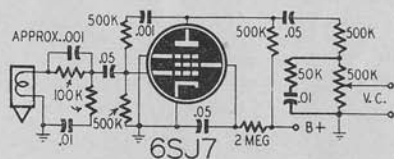
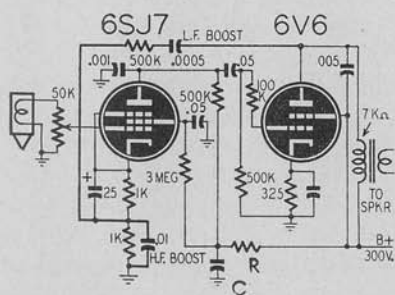

Fig. 23—above—This circuit employs negative feedback direct to pickup.

Fig. 22—left—Negative feedback for tone control ($R=50,000$ ohms, $C=8 \mu\text{f.}$)

A procedure seldom employed but nonetheless effective is to use negative feedback direct to the pickup, arranging the circuit so that the amount of feedback is proportional to the pickup's impedance. This results in automatic compensation for the pickup resonances, for at these frequencies the impedance is high. Condensers can be placed in the feedback network to give bass boost and high-frequency compensation. To keep the amount of feedback independent of the volume, the volume control may be placed after the first tube, the output of the pickup being reduced to prevent overloading. This is shown in Fig. 23. Enthusiasts who have tried this circuit claim that it makes a cheap magnetic pickup sound like a first-class crystal (which means that it is easy to obtain excessive bass)!

VOLUME EXPANDERS

IN RECORDING music (particularly symphonic music), some passages may be so low as to be barely audible, while other portions of the same selection may be loud enough to vibrate the walls of a building. These loud passages cannot be properly impressed onto a record because the largest amount of volume that can be carried on a record is definitely limited to the width of the sound wave which the stylus or needle cuts

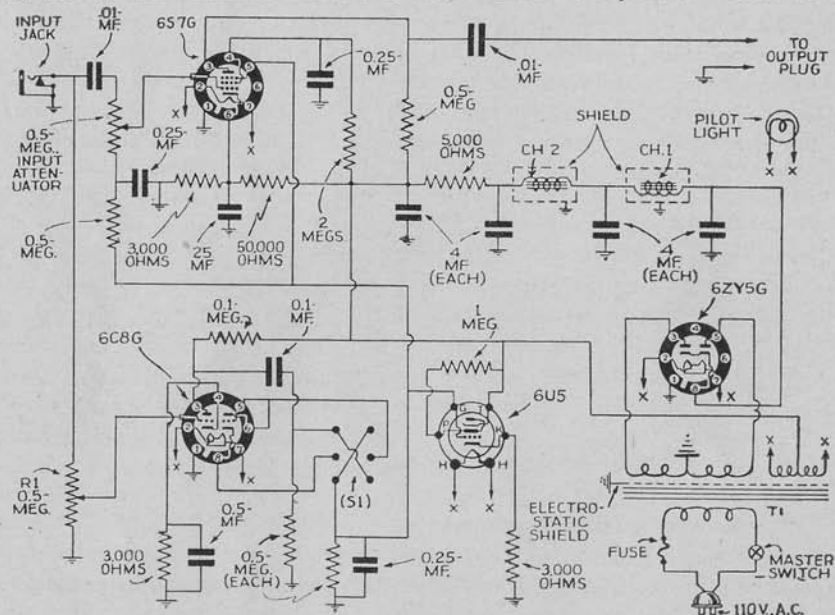

Fig. 24—Schematic of expander-compressor. 6U5 magic-eye tube is used to visually indicate degree of compression or expansion present.

on the soft wax master record. Too much volume will cause the stylus to break down the walls of the groove and jump into the next track. If this happens, the record is ruined. In order to avoid this condition, the music is carefully monitored (kept below this dangerous level). In other words, the very loud passages are made softer.

Conversely, very low passages make practically no impression on the

wax master. In fact, sound intensities below some fixed level are lost in the needle scratch. In order to remedy this condition, the very low levels are "built up" so as to definitely activate the cutting stylus.

The overall result of this recording procedure is to "condense" the dynamic range of sound intensities. Although most musical instruments individually can be subjected to this treatment without undue effect, the recorded version of a symphony orchestra is greatly affected.

If a well-monitored symphonic record is played back on any high-quality amplifier, it cannot sound real because the loud peaks have been depressed and the low valleys have been raised. For this reason, most symphonic records are characteristically devoid of their original dynamic volume range and therefore sound flat and lifeless.

Sound engineers have long known the existence of this defect. The problem finally evolved around the development of several types of circuits which would expand the dynamic range in the *reproducing equipment*, thus neutralizing the effects of compression in recording. A well-engineered expander enables the recorded version to be played back as a reasonably exact replica of the original rendition.

The expander raises the peaks (makes the loud passages louder). This produces the effect of lowering the valleys or making the low passages lower. In this device we have the equivalent of an a.v.c. circuit working in reverse. And one of the interesting points about the expander is that if the polarity of the controlling voltage is reversed, the circuit becomes an a.v.c. or compression circuit with a tendency to maintain the output of the amplifier at a constant level. Many commonly-used circuits have a voltage-reversing switch so that the circuit may be changed from a compressor to expander at will.

Two expander circuits are described here. The first uses a remote cut-off pentode, such as a 6S7-G, for the controlled tube.

Fig. 24 shows how the input signal is fed into both the 6S7-G remote plate current cut-off tube and the control amplifier section of the 6C8-G.

The control section amplifies the input signal and rectifies it in the diode section. The rectified voltage which appears across the .5 meg diode load resistor is applied through a time-delay circuit to both the

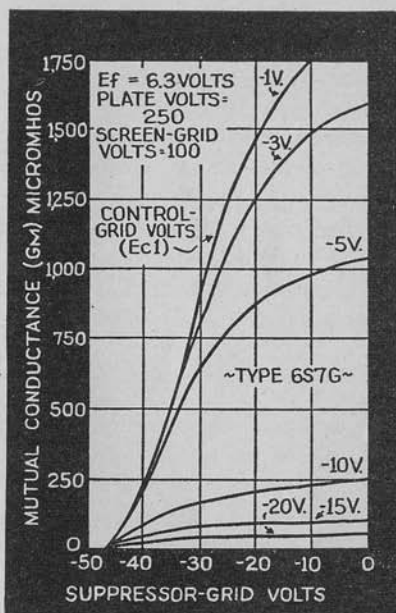

Fig. 25—Effect of control-grid and suppressor-grid bias change on mutual conductance of 6S7-G.

control grid and the suppressor grid of the 6S7-G. A time-delay circuit is inserted in the control grid circuit to produce a pleasing rate of expansion. The suppressor grid, however, acts more rapidly (although not as effectively) to preserve expansion of staccato passages. It will be noted that during expansion a positive voltage is developed across the rectifier section. This lowers the effective bias on the 6S7-G and raises its mutual conductance.

Fig. 25 shows how the mutual conductance of the 6S7-G is increased by lowering the control-grid bias and the effective suppressor-grid voltage.

The reversing switch (S1) reverses the rectifier output voltage and causes the negative voltage to be applied to both the control and suppressor grids. This effectively reduces the mutual conductance of the tube and lowers the output voltage when high input signals are present. Its action exactly complements the performance of the expander. In fact, reverse expansion actually takes place. By proper adjustment of R1, a constant output voltage can be maintained over the wide range of input-signal levels so that effective, automatic audio volume control will take place.

By feeding a microphone to the input, either expansion or compression can be applied to voice or music pickup. Ordinarily, the expander should not be applied to speech. The expander position, however, will add some expression to a monotoned orator.

Advantage of audio a.v.c.

A striking demonstration of the value of automatic audio volume control can be shown by adjusting the maximum output of the system to identical values with and without compression. The use of the compressor will then result in material increase of power output at reduced input signals. *In other words, should the orator turn away from the microphone, the sensitivity of the system will automatically increase, so as to maintain, within very narrow limits, a constant output.* This extraordinary effect is highly desirable in installations where performers resent the idea of burying their faces in the microphone.

By connecting the phonograph pickup to the input jack either expansion or compression can be applied to recordings. If the maximum output level of the system be adjusted to identical values with and without expansion, the use of the expander will appear to materially reduce scratch. If the low-level passages are adjusted to provide equivalent output with and without expansion, it will be noted that high-level passages will greatly increase the power output over the normal high-level output of the system, and thereby produce a much-desired realistic playback performance. It is of course taken for granted that the power amplifier will handle this higher output without introducing undue distortion.

On the other hand, should recordings be used in large dance halls where a constant sound level is desired, compression may be applied

to provide a more uniform output, regardless of fluctuations in recordings.

It will be noted that the unit employs a 6U5 cathode-ray indicator to visually indicate the degree of compression or expansion present. The power transformer is equipped with an electrostatic shield and is capable of supplying 280 volts each side of center tap with a 50-milliampere load. Two 50-henry 50-milliampere chokes (CH1 and CH2) are used with a 5,000-ohm resistor and 16 microfarads of capacity to provide adequate filtering of the plate- and screen-supply voltage.

The schematic of the unit shows input and output provisions for working from and into a high-impedance load. Input and output transformers may be used to permit working from a low-impedance mike into a line or low-impedance load.

Hum, usually produced from heater-to-cathode and heater-to-plate

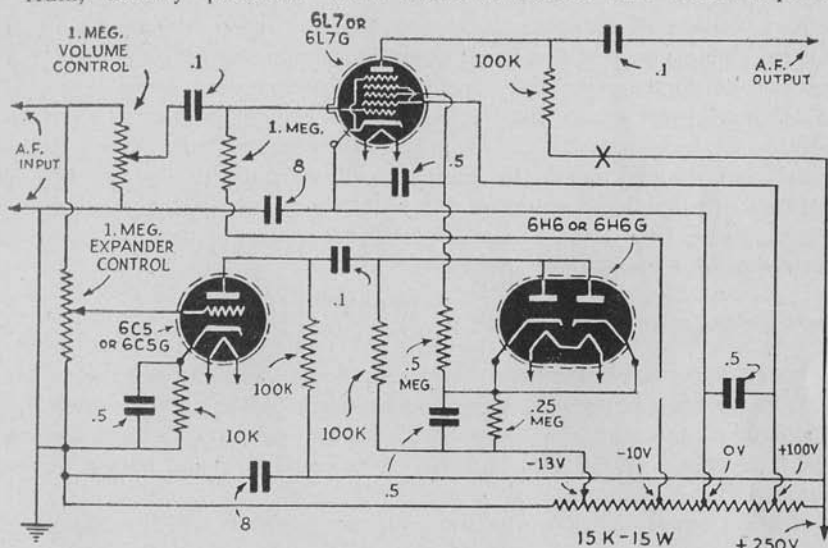

Fig. 26—Another type of volume expander.

emission, has been completely eliminated by raising the heaters 200 volts above ground, so that the heater potential is higher than any other element in the 6S7-G, thereby effectively preventing emission to the screen-grid, cathode, and plate circuits. This high bias potential does not affect the performance of the other tubes in the unit.

The addition of this "expressor" to any microphone or phono circuit will not only add considerable flexibility to the reproducing ability of the amplifier system, but will also add approximately 20 db to any input circuit (when volume control is on full). This will permit the use of low-level microphones with amplifiers designed for high-level inputs. In other words, the unit may also be used as a pre-amplifier when additional gain is desired.

Another expander circuit is shown in Fig. 26. In this circuit the output

of the amplifier is controlled in the 6L7 tube. A signal from the phonograph pickup is fed simultaneously to the control grid G1 of the 6L7 and grid of the 6C5. The signal level on these tubes is controlled by the settings of the volume and expander controls, respectively. The setting of the expander makes it possible to control the input to the 6C5 expander amplifier, regardless of the input to the 6L7 control tube. Both controls should be placed at some convenient place on the chassis so that they can be readily adjusted.

The signal on the grid of the 6C5 is rectified by the 6H6. The voltage developed across the .25-meg diode load resistor is applied to the second control grid G3 through a .5-meg resistor and the .5- μ f bypass condenser. Note that the resistor connects to the *positive* side of the diode load resistor.

G3 is in the electron stream between G1 and the plate. Variations in voltage on this grid will affect the mutual conductance of the tube and increase or decrease the amplification. If the expander control is turned to minimum position so that the 6C5 grid is grounded, there is no rectified output from the 6H6 and G3 is 13 volts negative with respect to the cathode of the 6L7. With this high bias the amplification of the 6L7 is reduced considerably because of the reduction in mutual conductance.

Action of expander control

When the expander control is advanced so that the signal is amplified by the 6C5 and rectified by the 6H6, the voltage developed across the diode load will buck the fixed bias and reduce it to -3 or 4 volts. This reduction in the effective bias will increase the mutual conductance and the gain of the stage. With carefully chosen circuit constants, the increase in amplification will be nearly proportional to the output of the diode.

It is recommended that a milliammeter be inserted at "X" in the plate lead of the 6L7 and the initial bias on G3 adjusted (-13-v slider on voltage divider) to the point where the plate current is about .15 ma. In the 6L7, G1 is designed so that the tube has a remote cut-off characteristic and the maximum signal on this grid should be kept at a low level to prevent distortion.

The .5-meg resistor and .5- μ f bypass condenser not only serve as a coupling means between the 6H6 diode load but also as a time-constant control. Speech is far from satisfactory if the time-constant is too short, and if it is too long, there will be an objectionable lag which should be avoided. For average reproduction of speech and music, a time constant of .25 to .5 second will prove to be satisfactory. Variable time lag may be provided by placing a 1-meg. variable resistor in series with the .5-meg resistor to provide a range variable between .25 and 1.5 seconds.

This expander circuit may be used as a pre-amplifier working into a high-impedance input of a conventional amplifier.

DECIBEL LEVEL VS. GAIN

AMPLIFIERS ARE rated according to the number of watts output they can handle without distortion. The output depends upon the size and design of the amplifier. This output tells what volume of sound will come from a system and the area that can be covered with the installation.

The amplifier performs but one important function: To receive the voice of the speaker or music and raise the volume to a much higher level so that the sound energy may be heard by many people over a fairly large area.

Before the gain (amplification) of an amplifier can be measured it is



Fig. 27—Expressions used in explanation.

necessary to select some unit of measurement. As the output of the amplifier is rated in terms of *watts* it would be logical to measure the input in terms of watts also. Now the effect of sound energy on the ear is not a direct (arithmetic) function but varies in an exponential way. Therefore, the gain of an amplifier is expressed in the same way, by means of logarithms. The expression is given by the formula:

$$db = 10 \log_{10} \frac{W_o}{W_i}, \text{ where } db \text{ represents the unit of transmission or}$$

amplification—the *decibel*; W_o is the power output; and W_i is the power input. The formula states that the *decibel gain* is equal to ten times the logarithm of the efficiency of the amplifier. Efficiency is here used in connection with *sound energy* and does not mean the electrical efficiency which is usually very low. The above formula will hold at all times in rating amplifiers.

Amplifiers can also be rated in terms of currents and impedances.

Referring to Fig. 27, the formula is:

$$db = 10 \log_{10} \frac{I_o^2 R_1}{I_1^2 R_1} \text{ or } db = 20 \log_{10} \frac{I_o}{I_1} + 10 \log_{10} \frac{R_1}{R_1}$$

If the resistance of the input impedance equals the load resistance, the last term becomes zero and the first term gives the decibel gain. In some designs, however, the second term may be considerable and must not be neglected in such cases.

The gain may also be rated in terms of input and output voltages, provided the input and output reactances are equal to zero; that is, when both impedances are *resistance* only. The formula is:

$$db = 10 \log_{10} \frac{E_o^2}{E_1^2} \text{ or } db = 20 \log_{10} \frac{E_o}{E_1} + 10 \log_{10} \frac{R_1}{R_1}$$

Again the last term equals zero, if the input and output resistances are equal.

Sound and noise levels are usually expressed in decibels and not in watts, therefore a reference level of zero decibels must be set. For convenience, engineers have arbitrarily taken the output of a common-battery telephone transmitter (when spoken into with a loud voice) as zero level. This equals .01 watt or 10 milliwatts. The output of a standard transmitter used by telephone engineers is also 16 milliwatts. Thus in telephone work zero level has been set at 10 milliwatts. The tendency among radio engineers is to refer the system to a zero level of .006 watt or 6 milliwatts and throughout this book all levels are with respect to 6 milliwatts. It is of very little importance whether the level is 10 or 6 milliwatts as long as one or the other is taken as standard!

By using 6 milliwatts as zero level, amplifiers may be rated at an energy level of a certain number of decibels. This is desirable because the ear responds to sound in a logarithmic manner. This can be illustrated by the following example. If an amplifier delivers 6 watts output it has a level of:

$$db = 10 \log_{10} \frac{6}{.006} = 10 \log_{10} 1,000 = 30.$$

Now, if the output is doubled, the ear will notice an increase in volume but not twice as great as the 6-watt output because the ear will respond *as the increase in decibels* and not as the increase in watts output. Thus:

$$db = 10 \log_{10} \frac{12}{.006} = 10 \log_{10} 2,000 = 33.$$

The ear did not detect the increased volume in a direct ratio, but *as the logarithm of the ratio*. Therefore, if this zero reference level were not used, the amplifier control set at 30-db gain would not give any indication of the volume of the output unless the input were known. With the control marked in decibels above zero level, the 30-db setting would indicate an output of 12 watts.

A commercial amplifier rated at 26 watts output has an energy level, at full output, expressed in decibels equal to:

$$\text{db} = 10 \log_{10} \frac{26}{.006} = 10 \log_{10} 4,333 = 10 \times 3.64 \text{ or } 36.4 \text{ db.}$$

Now it is stated in the catalog that this amplifier has a gain of 96.4 db. Where do the extra 60 decibels come from? The answer to this question will become evident after the microphone output has been considered.

Microphone level

Different types of microphones have different energy output levels, but most commercial-type PA microphones give an energy level of —50 to —80 db. When the source of sound is near the microphone, a good average is the —60 db level. The microphone, therefore, lowers the energy level that it receives and it is the function of the amplifier to raise the voice level from —60 db back to zero level *and still higher* in order to have appreciable output at the loudspeaker. After the sound has passed through the microphone, it is at a very low level and has very little energy. The actual power impressed on the amplifier input by the microphone is found as follows:

$$(1) \text{ —60 db} = 10 \log_{10} R; \text{ where } R = \frac{\text{Mic}_{\text{out}} \text{ (Microphone sound input is assumed to be 0 db or .006 watt)}}{\text{Mic}_{\text{inp}}}$$

$$(2) \text{ —6} = \log_{10} R$$

$$(3) R = \frac{\text{Mic}_{\text{out}}}{.000,001}$$

Therefore: $\frac{\text{Mic}_{\text{out}}}{.006} = .000,001$ and $\text{Mic}_{\text{out}} = .000,000,006$ watt.

Thus the input of zero level to the microphone is lowered to —60 db in passing through the microphone and the power that the amplifier begins with is very small. The entire gain is therefore 96.4 db as the amplifier ends up with a +36.4-db level. In amplification work it is desirable to know to what level above zero the amplifier will raise the sound of the speaker's voice, and, therefore, the maximum reading on the control should be 36.4 db and not 96.4 db. A high-gain amplifier when used with a low-level microphone may not produce a high level. For example, suppose the microphone had an output of —76.4 db. This, added to the amplifier's total gain, would produce an output level of 20 db above zero. The output would be far below the rated 26 watts and would be equal to:

$$20 = 10 \log_{10} R, \text{ or } 2 = \log_{10} R, \text{ or } R = 100 = \frac{W_o}{.006}$$

or the output W_o equals .6 watt. After all, the decibel gain is not so important. *It is the decibel level above zero that counts.*

Table I lists the efficiency for certain decibel gains or losses. The table's use can be demonstrated by means of the following examples. It is well to point out that the table may be used for any value of decibel gain. Suppose the efficiency at 15-db gain is to be found. Fifteen decibels equal 10 db plus 5 db, but the resulting efficiency is the product of the efficiencies at 10 db and 5 db. A 15-db gain gives an efficiency of $10 \times 3.16 = 31.6$ or 3,160 percent.

Table I

Eff. (%) for given db gain	Number of db	Eff. (%) for given db loss
100	0	100
112	1/2	89.1
126	1	79.4
158	2	63.1
200	3	50.1
251	4	39.8
316	5	31.6
398	6	25.1
501	7	20.0
631	8	15.8
794	9	12.6
1,000	10	10.0
10,000	20	1.0
100,000	30	0.1
1,000,000	40	0.01
10,000,000	50	0.001

Let us now use this 15-db gain in a problem. A man starts out with \$2.00 and at the end of two weeks he has a 15-db gain which is an efficiency of 3,160 percent. Therefore, at the end of two weeks the man has \$63.20. The man's son also has a decibel gain of 15 at the end of two weeks but he started with 50 cents. His efficiency is also 3,160 percent but instead of having \$63.20, like his father, the boy has only \$15.80. Again it is seen that the db gain is not as important as the db level above a certain reference point. Suppose the reference point chosen by the two is \$5.00, and this is zero db level. The man at the end of two weeks has a level of:

$$\text{db} = 10 \log_{10} \frac{63.20}{5} \text{ or } \text{db} = 10 \times 1.004 \text{ or } 10.0 \text{ db.}$$

The boy has a db level of:

$$\text{db} = 10 \log_{10} \frac{15.80}{5} \text{ or } \text{db} = 10 \times .4997 \text{ or } 4.99 \text{ db}$$

which we shall call a 5-db level.

With the level above as the reference point, it is at once evident that the father has more money than his son. Both still have the same *gain*, however. In this case the man began with a -5-db level and finished with +10 db, a gain of 15. The boy began with a -10-db level and ended with a +5-db level which is also a 15-db gain.

A DECIBEL NOMOGRAPH

A HANDY nomograph is one relating decibels to voltage or power ratio. The three variables are input, output and decibels. In the figure, the left-hand scale is calibrated in values from 1 microvolt to 100 volts in two sections, A and B. The right-hand scale indicates from .5 volt to 500 volts. The center scale shows decibels in two sections, C corresponding to A and D corresponding to B.

As the nomograph stands it indicates voltage gain or loss, but since current varies directly with voltage in any constant impedance circuit, amperes may be substituted for volts and microamperes for microvolts. *To extend to power values, divide the center scale by two for all readings.*

To work out a problem, connect the larger of the two voltages, currents or powers at scale E with the smaller at either A or B, using a ruler. If the output is larger there is a gain, otherwise a loss. The answer is read off at C or D.

1—We wish to find the voltage gain of an audio amplifier. Making measurements with a v.t.v.m. we find the output is 55 volts when the input is .15 volt. There is a gain of 51.3 db (Line A).

2—We have an r.f. tuner and after repairing and aligning we wish to find its amplification. Applying a signal generator to an artificial antenna we find an output of 3 volts when 1,600 microvolts is measured at the input. The gain is 65 db (Line B).

3—How much attenuation must we use to obtain an output of .51 volt when 20 volts is applied to the attenuator? All impedances are assumed matched. We must design an attenuator to have a 31.9 db loss (Line C).

4—As mentioned before, power calculations are the same except that the db scale is read off as one-half its value. The catalog lists a particular amplifier as having 10 watts output. What is its power gain (above 6 milliwatts)? Connect 10 at E with 6,000 at A. The gain is 64.2 divided by 2, or 32.1 db (Line D).

5—Another useful transformation is that of percentage to decibel loss. Amplifiers are sometimes rated in percentage distortion or noise and sometimes in db down from the rated output. Only two variables are concerned, percentage and decibels. To operate, the ruler is kept fixed against the bottom indication of the left-hand scale at all times. Percentage

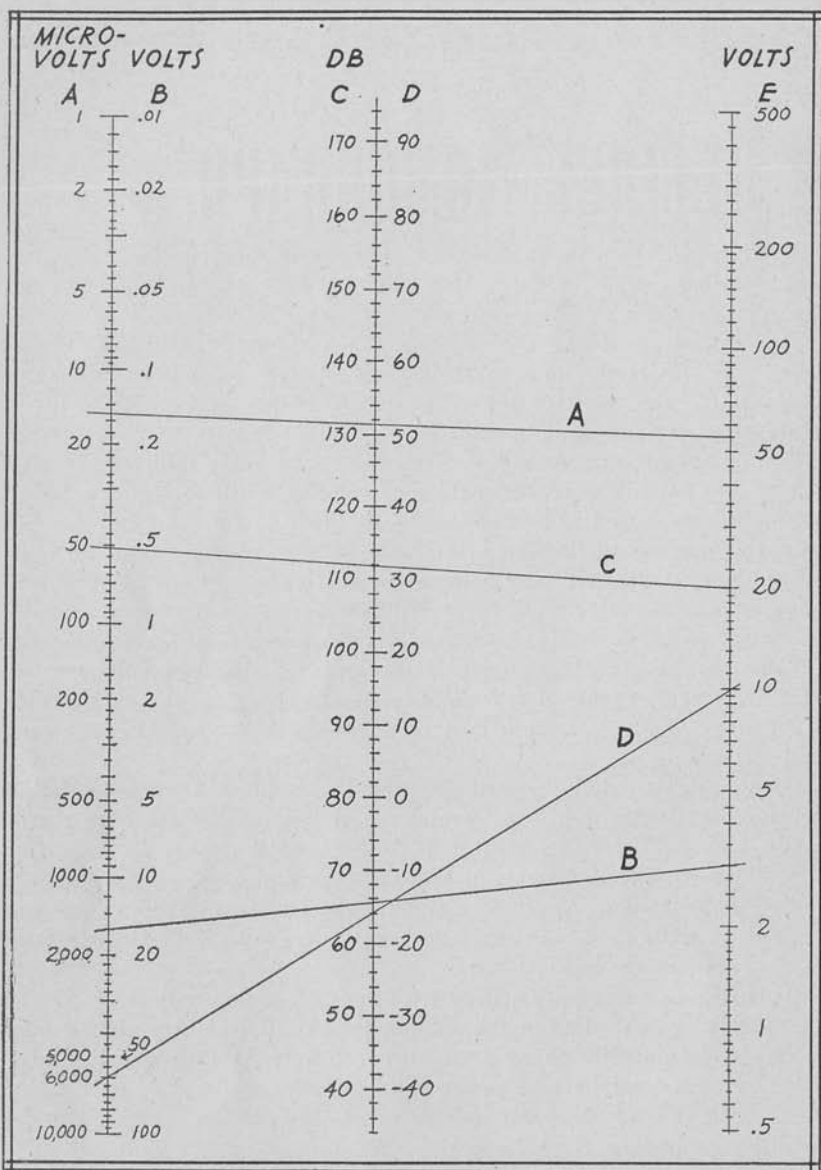

is read at E, while db down is read at D. A particular amplifier is known to have 2 percent distortion. How many db down is this? Place one end of the ruler at 100 volts at the bottom of scale B and the other end at 2 volts (2 percent) on E. We read -34 db on D. But since we are dealing with power rather than voltage, this reading must be divided by 2. The result: -17 db. Distortion is 17 db below output power level.

AN 8-WATT PA SYSTEM

HERE IS a complete PA system that can be built at comparatively low cost. It is ideal for PA work at dances, for orchestras, and singing, and all general ballyhoo work.

The system was designed as a low-cost amplifier with an 8- to 10-watt output, and that would give excellent fidelity.

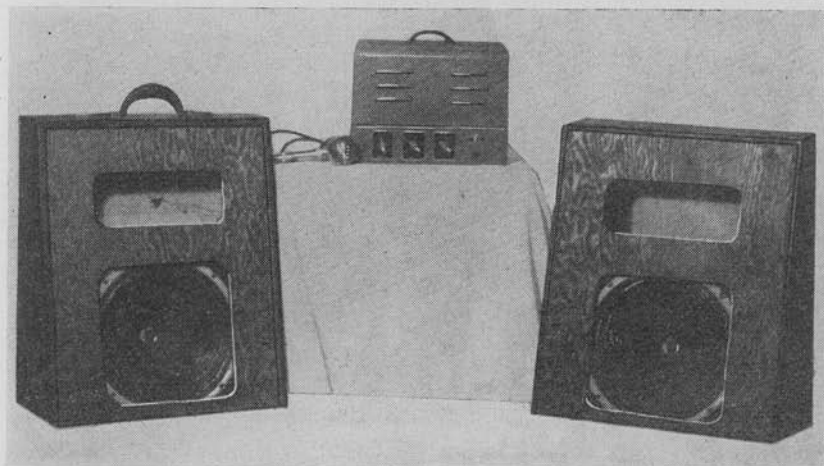

Fig. 28—Loudspeakers with amplifier in center.

The amplifier was designed to be very simple to build. Resistance coupling is used throughout. This enables one to obtain excellent fidelity and gain, without the use and expense of interstage transformers.

A 6J7 high-gain pentode stage is used as a microphone pre-amplifier. This has a high-impedance input and will take almost any level of high-impedance microphone. Because of the high gain of this stage, hum may

be picked up in both the plate and grid circuits; for this reason both circuits should be well shielded. A bias cell is used instead of cathode bias; this design insures hum-free performance.

The microphone stage mixes into a 6SF5 along with the high-impedance



Fig. 29—Appearance of amplifier's top deck.

phonograph channel. The tone control, *phono* and *mike* input jacks, and associated gain controls are mounted conveniently on the amplifier chassis. There is also another input circuit, mixing into the second grid of the 6SF5; this comes from the phonograph input.

These three channels can be mixed simultaneously with absolutely no interaction. This is due to the 500,000-ohm resistors in series with the volume controls that always keep the grid above ground.

This mixing stage is resistance-coupled to the final power output stage. A 6L6-G beam power tube is used in this stage because of its high power sensitivity, high power output for relatively small inputs, and high efficiency. It has very low third and negligible higher harmonic distortion.

A very simple method of inverse feedback is employed. A portion of the plate voltage (determined by the value of feedback resistor R14), is tapped off the 6L6-G plate and fed back to the grid. This feedback voltage is out of phase with the input voltage and tends to cancel out distortion generated in the plate circuit of the 6L6-G. This makes the distortion in the output circuit of the 6L6-G comparatively low. The output is slightly lowered by this arrangement but may be brought up again by applying more driving voltage.

The output transformer has secondary taps at 2, 4, 8 and 500 ohms. These taps are brought out to two speaker plugs in parallel on the back

of the amplifier, so that by selecting the proper terminals, the proper impedance values can be chosen for the speakers.

The 500-ohm line is also brought out to two banana plugs in the rear. This facilitates measurements on the amplifier under actual operating conditions. The 8-ohm tap is brought out to a terminal strip marked OUTPUT. This is a convenience terminal for an auxiliary speaker.

Two 12-inch PM speakers are used. The speakers have voice-coil impedances of 6 to 8 ohms and will handle 10 to 15 watts. Both speakers are wired with 50 feet of rubber-covered lamp cord. Thus they may be put in convenient places to get maximum coverage of a given location and also to prevent feedback to the microphone. The speakers are connected in parallel across the 4-ohm tap on the output transformer. The loss in running the voice-coil wires through that length of speaker cable is less than 1 db.

The speaker cabinets were built from one-half inch plywood. This design gives better bass response than that of a closed cabinet. The cabinet

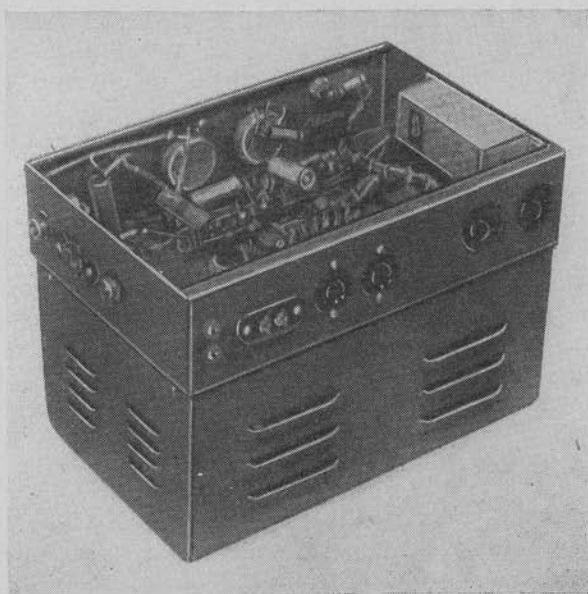

Fig. 30—Bottom view of the amplifier.

is cut diagonally through the center and the speakers set in so that it is easy to carry them about. The cabinets are fastened together with suitcase clasps and carried by the handle that is shown on top of one of them. The speaker inclosures are shown partially open so that the reader can see the construction to better advantage. The speakers are first mounted on a piece of sound-absorbing material such as celotex, in which a hole is cut to fit the size of the speakers. The speaker, on the

celotex, is then mounted on the sounding board. The sounding board is placed in the cabinet and secured by screwing to corner blocks put there for that purpose. The celotex baffles close up the leaks around the corners of the speaker openings, thereby making the chamber more efficient.

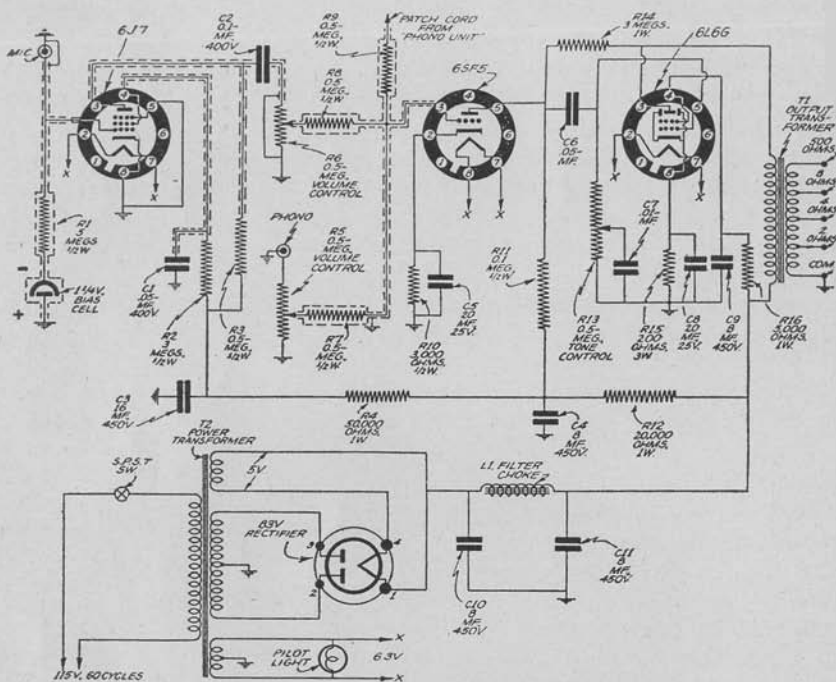

Fig. 31—Schematic of complete 8-watt amplifier.

The cabinets are nailed and glued together, stained and shellacked. After rubbing down with steel wool, a final coat of varnish is put on them to give a hard and lasting finish. Rubber feet help to keep the

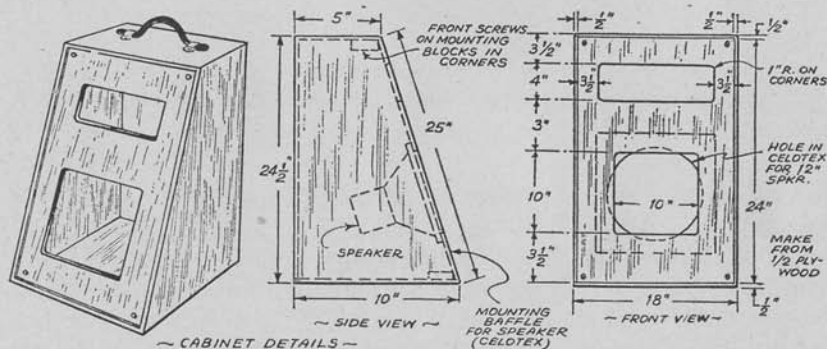

Fig. 32—Construction dimensions for loudspeaker cabinets.

cabinets from becoming marred. All necessary dimensions are shown in the accompanying sketch. The final touch is to cover the speaker and release openings with a piece of grille cloth. Wire screening may also be used for this purpose but will result in a loss of high frequency response. With a little care in designing and building the speaker cabinets, not only will surprisingly excellent response result, but the cabinet will be a nice looking piece of furniture.

In the power supply an 83-V tube was used because of its excellent voltage regulation characteristics. This is due to the close spacing between the cathode and the plate.

Common procedures should be followed in building the amplifier. Filaments should be wired with leads twisted, to cut down the electromagnetic fields around them, thereby reducing chances of hum pickup. All large parts, transformers, condensers, volume controls, etc., should be mounted first.

Small parts such as paper condensers, resistors, etc., should be mounted where it is convenient and where they will cause the least interaction between circuits. As indicated in the diagram, certain circuits should be shielded. Resistors R1, R7, R8 and R9 should be of the insulated type. The backs of all potentiometers should be shielded as well. These procedures if carefully followed will result in hum-free operation.

Make sure that tubes and speakers are installed before turning on the amplifier. The input circuits can then be used in safety. A burned-out output transformer may be the result of turning up the gain of any channel without speakers connected to load the output transformer.

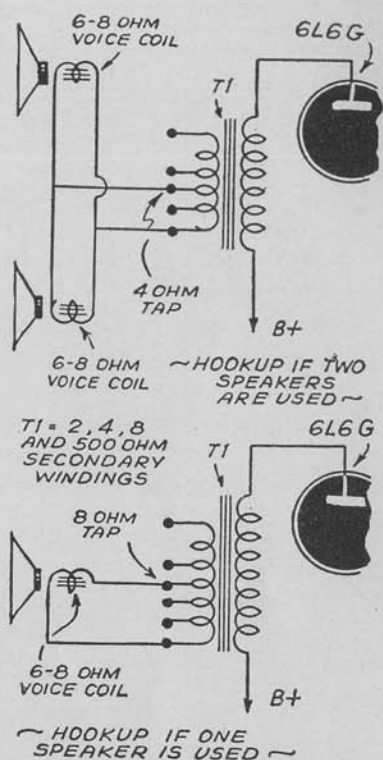

Fig. 33—Diagrams for connection of one or two speakers.

List of Parts

T1—Output transformer, single 6L6 plate (2,500 ohms) to line and voice-coil secondary (2, 4, 8, 500 ohms)
 T2—Power transformer, 800 v c.t. at 110 ma, 6.3 v at 3 amp, 5 v at 3 amp
 L1—Filter choke, 12 h at 150 ma
 1—6J7 tube
 1—6SF5 tube
 1—6L6-G tube
 1—83-V tube

1—Chassis 8 x 12 x 9 inches
 2—Terminal strips (2-terminal)
 1—S.p.s.t. toggle switch
 2—P-M speakers, 12-inch diameter, 10-15 w. 6-8-ohm impedance
 1—High-impedance microphone
 3—Octal sockets
 1—4-prong socket
 Condensers and resistors as per schematic

16-WATT FM AMPLIFIER

THIS HIGH-fidelity amplifier is designed for use with an FM tuner. Its power supply is capable of supplying plate and filament voltages for the tuner.

For simplicity and ease in construction, the amplifier consists of three stages: The first stage, using a 6J5 tube, is the phase inverter, needed for supplying two out-of-phase voltages to the succeeding push-

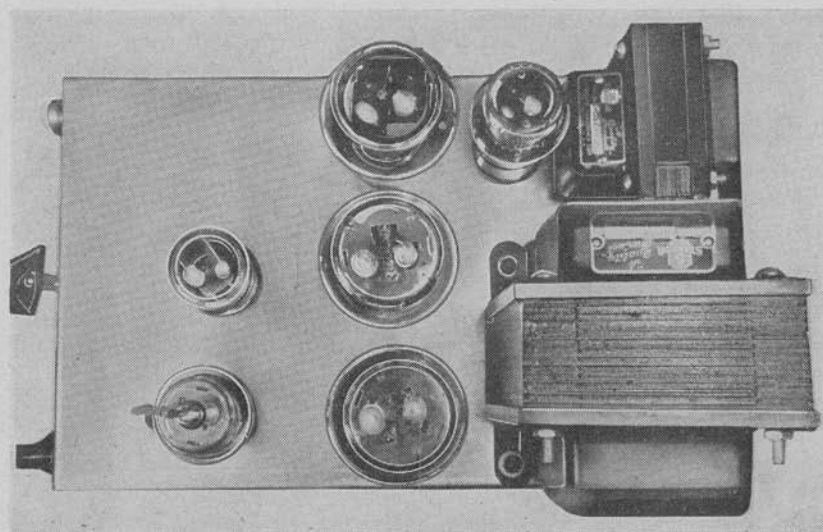

Fig. 34—Top view of the high-fidelity amplifier.

pull driver stage. This stage employs a 6C8-G dual triode and feeds the push-pull 6L6-G output tubes. About 16 watts of undistorted audio power is obtained here, more than enough for a good-sized home, but the reserve power is assurance of distortion-free operation. A 5X4-G is used as a rectifier, while a VR-105 voltage regulator tube is optional.

The entire unit is easily accommodated on a 7 x 11 x 2-inch chassis, even leaving some spare room in one corner. But this may come in handy later on, if it ever becomes desirable to install a high-gain input stage to increase the overall gain, so that low-level microphones can be used.

filaments are not heated. If the constructor has no desire to use the amplifier with any tuner other than the FM unit, he can omit this switch and the second power-output receptacle as well as one of the input receptacles.

Although not shown in the diagram, the six sections of the rotary switch have been paralleled to give a three-pole, three-position switch of increased current-carrying capacity. Reference to the diagram will show that the switch is so wired that when it is in the center position, the amplifier is turned *off*; when moved to either side of center the amplifier is *on*, and filament voltage switched to one of the power receptacles. Incidentally, the switch was mounted toward the rear of the chassis to keep the a.c. leads away from the input tubes, necessitating the use of a mounting bracket and extension shaft.

The phase inverter

The phase inverter used is of the type in which the out-of-phase voltage is obtained from the cathode circuit. Actually, the 25,000-ohm resistor at the ground end of the 6J5 cathode is really part of the plate circuit. Where additional amplifier gain is not needed, this form of phase inverter is preferable (from the standpoint of simplicity) to the double-triode type, and was used for this reason.

Notice the 250,000-ohm resistors connected from the plates of the 6L6-G tubes to the plates of the 6C8-G tubes. These are the feedback resistors furnishing negative feedback which contributes so much to the excellent frequency response, and to the hum-free operation.

This method of feedback was purposely used, so that the constructor would have no trouble in getting the amplifier to operate properly the first time it is tried out. The polarity or magnitude of the feedback voltage is not dependent on the output transformer, so the constructor need not fear that the amplifier will squeal and howl like a banshee when first turned on. Incidentally, no output transformer was incorporated on the chassis, because the speaker used by the writer has the transformer built onto it.

List of Parts

- | | |
|---|---|
| 1—600-ohm, $\frac{1}{2}$ -w resistor | 2—Input connectors |
| 1—3,000-ohm, $\frac{1}{2}$ -w resistor | 1—8-8-8- μ f, 450-v elect. cond. |
| 2—25,000-ohm, $\frac{1}{2}$ -w resistors | 3—1- μ f, 400-v condensers |
| 1—50,000-ohm, $\frac{1}{2}$ -w resistor | 2—.05- μ f, 400-v condensers |
| 4—500,000-ohm, $\frac{1}{2}$ -w resistors | 2—10- μ f, 25-v elect. condensers |
| 4—250,000-ohm, $\frac{1}{2}$ -w resistors | 1—10- μ f, 50-v elect. condenser |
| 2—100,000-ohm, $\frac{1}{2}$ -w resistors | 1—4- μ f, 450-v elect. condenser |
| 1—150-ohm, 10-w resistor | 1—Power transformer, 675 v, 175 ma, c.t.; |
| 1—6,000-ohm, 10-w resistor | 5 v, 3 amp; 6.3 v, 5 amp |
| 1—1-meg volume control | 1—175-ma, 20-h choke |
| 1—7 x 11 x 2-inch chassis | 1—75-ma, 30-h choke |
| 1—7 x 11-inch bottom plate | 1—Push-pull plate to voice-coil output |
| 2—Octal steatite sockets | transformer 5,000 ohms c.t. primary |
| 4—Octal sockets | 1—6-pole, 3-position rotary sw. |
| 2—5-prong sockets | 2—6L6-G tubes |
| 1—5-prong plug | 1—5X4-G tube |
| 1—3-prong receptacle | 1—6C8-G tube |
| 1—3-prong plug | 1—6J5 tube |
| 2—Input receptacles | 1—VR-105 tube |

10-Watts—Direct Coupled

THE ADVANTAGES of direct-coupled amplifiers have been known for a great many years, but the inability to attain a simple and practical direct-coupled inverter, in order to achieve push-pull output and its many attendant advantages, offered a serious handicap to the popular use of this circuit.

Direct coupling overcomes objectionable characteristics of transformer coupling (core saturation, magnetic lag, and transformer resonance)

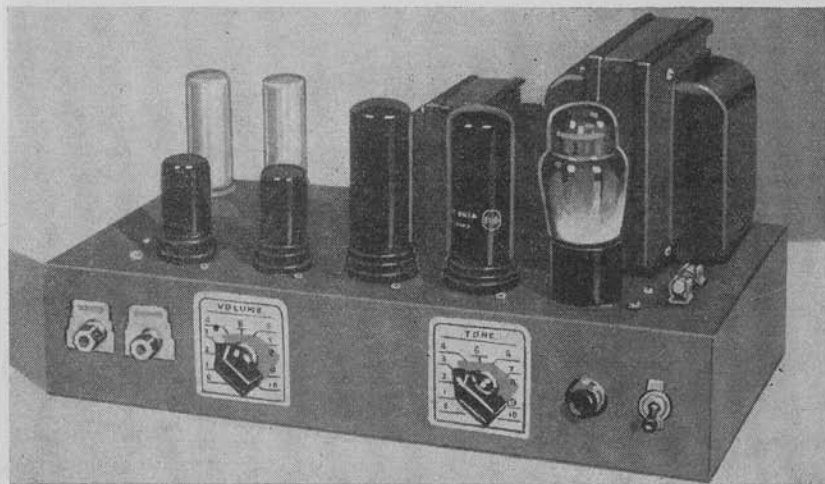

Fig. 37—Layout of push-pull, direct-coupled amplifier.

and resistance coupling (short circuiting of weak signals and grid blocking of strong signals). Furthermore, it is unsurpassable from a simplicity standpoint (only 9 resistors and the usual output transformer plus filter supply are required to attain extraordinary results).

The question may well be raised, "If this type of a circuit is so extraordinary, why is it not more popular?" The answer is found in the usual objections offered to direct-coupled circuits, plus the fact that because of its unusual arrangements it has not received deserved attention from design engineers.

The usual objections to the direct-coupled amplifier are:

- (1) Instability.

- (2) High voltages required.
- (3) Critical hum-balancing adjustments necessary.
- (4) Variations of characteristics in similar-type tubes affect voltage distribution within the amplifier.

How this amplifier overcomes these objections is indicated below:

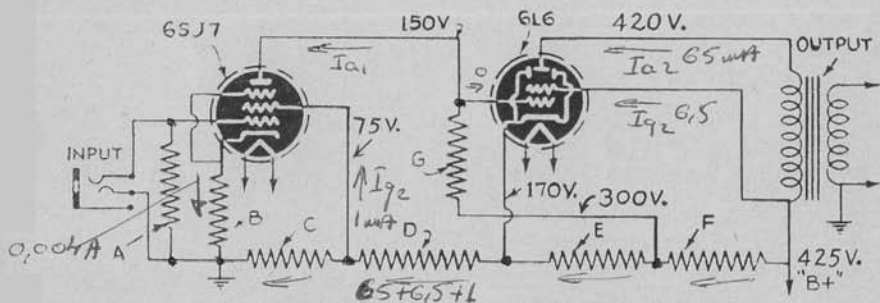

Fig. 38—Basic direct-coupled circuit used in amplifier.

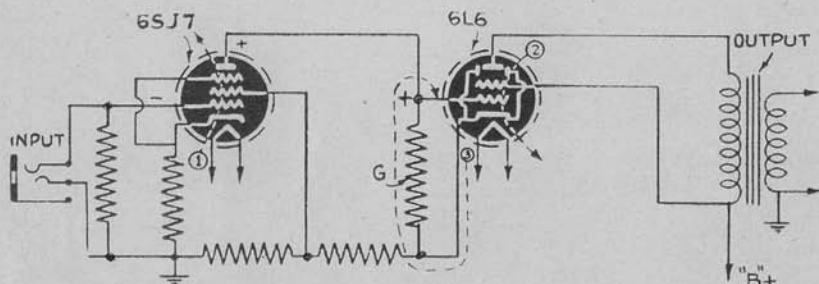

Fig. 39—Conventional method of obtaining grid bias for output tube.

1—Complete stability of this circuit is attained by applying stabilized and self-balancing voltages to control elements.

2—The highest voltage required for this particular amplifier is approximately 430 volts. It is simple to safely handle this voltage by using two 450-volt condensers connected in series. Such a combination will handle 900 volts, and makes available a safety factor of 100 percent, which exceeds, by far, safety factors employed in usual commercial amplifiers.

3—Critical hum-balancing adjustments are not required in a truly all-push-pull direct-coupled amplifier, inasmuch as all filter hum voltages automatically cancel themselves.

4—Variations in characteristics of similar-type tubes will not detrimentally affect the distributed potentials within the amplifier, as any such unbalance between corresponding tubes will automatically tend to produce equivalent unbalance in its adjacent channel.

To understand the operation of a direct-coupled amplifier, it is necessary to realize that its basic principle depends upon the direct connection

of a plate of an input tube to the grid of an output tube. Both of these elements have the same applied potential, but suitable corrections are applied to the output tube so that the effective bias and plate voltages are in conformance with standard ratings.

Voltages are distributed within a direct-coupled circuit as illustrated in Fig. 38. It will be noted that 150 volts is applied to the plate of the input tube, as well as to the grid of the output tube, but 170 volts is

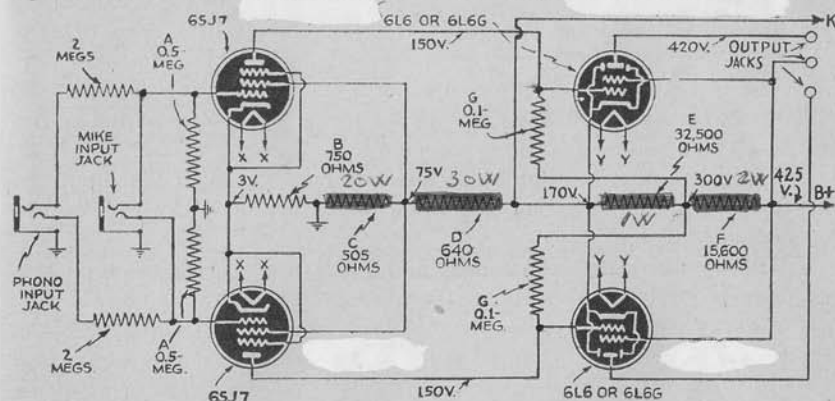

Fig. 40—Schematic of 10-watt direct-coupled amplifier.

applied to the cathode of the output tube so that the effective bias (looking from cathode down to the grid) is 20 volts. Although the plate potential is 420 volts (from ground) its effective potential is only $420 - 170$, or 250 volts, as measured from cathode to plate.

The first step in the design of the direct-coupled amplifier, is to determine (a) power output required, (b) highest voltages desired in the power supply, and (c) the necessary gain. Let us assume that our specifications call for the following conditions:

Power Output: 10 watts with less than 2 percent total harmonic distortion.

Power Supply Voltage: Not to exceed 450 volts (to avoid excessively high voltages, and assure adequate safety factor of any filter design).

High Gain Input: 90 db (to operate in conjunction with medium-level microphones).

Medium Gain Input: 70 db (for crystal pickup or radio set).—

A cursory examination of available tubes would lead us to select two 6L6's for the output stage, operating with 250 volts on the plate and

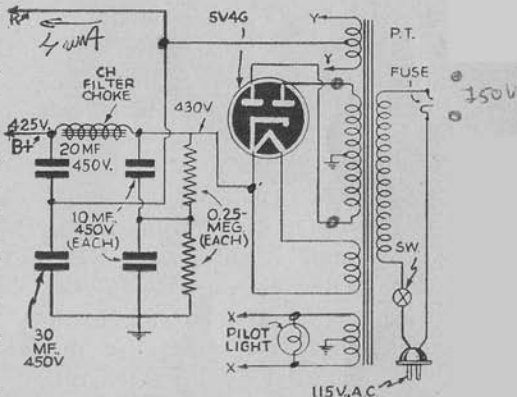

Fig. 41—Schematic of power supply.

screen grid, which, according to standard ratings, will develop approximately 14 watts at 2-percent harmonic distortion.

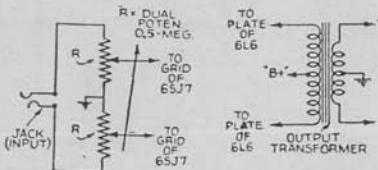

Fig. 42—Push-pull input and push-pull output connections.

150 volts for the plate of the input tube. A 6SJ7, operating with approximately 150 volts on the plate and 75 volts on the screen grid, will satisfy our conditions for gain.

For medium gain, an additional attenuator is placed in the input circuit to drop the input signal 20 db, so that a crystal pickup easily can be accommodated.

It will be noted, that resistors E and F are used across the high B+ and cathode of the 6L6 to obtain the plate potential for the 6SJ7's. This simple expedient avoids objectionable "trigger action," which was predominant in early direct-coupled amplifier designs. Inasmuch as the grid potential of the 6L6 is lower than the cathode potential, the original designers were tempted to obtain this voltage directly from the cathode, as illustrated in Fig. 39. This circuit is greatly susceptible to "trigger action," because of the following sequence of events:

(1) When an instantaneous negative potential appears on the grid of the input tube, less plate current flows, and a smaller voltage drop takes place in the plate resistor G, so that the plate potential of the 6SJ7 tends to rise. Naturally, the grid potential of the 6L6 also rises, which in turn decreases the effective bias of the output tube, and (2) increases its plate current, so that higher potential appears at the cathode, which (3) in turn raises the potential (through resistor G) on the output grid.

This cycle of events continues until plate current becomes excessive and the tube is thrown off its E_g-I_p curve, and maintains itself in a blocked position. By employing resistors E and F (Fig. 38), the plate potential of the input tube is independent of the plate current of the output tube.

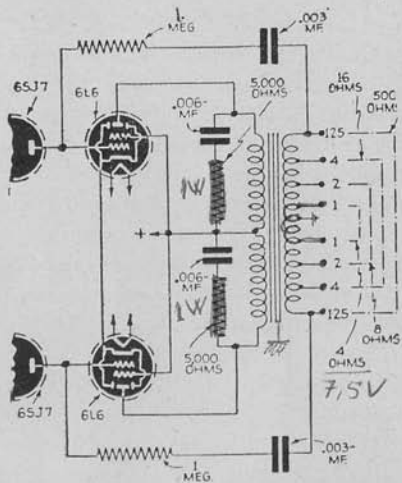

Fig. 43—Push-pull inverse feedback and compensating network for high-fidelity results with low-price transformer. Feedback voltage comes from the 500-ohm tap on the secondary of the output transformer.

A large number of tubes (of the same type) were interchanged in the amplifier without noting any appreciable difference in performance. Reasonable variations in plate or screen-grid currents of the 6L6 output tubes cancel at their cathodes. Variations in the input 6SJ7 tubes are likewise cancelled at the junction of their cathodes. It is obvious, of course, that any tube which will not operate satisfactorily in a standard audio amplifier should not be used in this amplifier.

The design procedure necessary to calculate the values of the important six resistors required makes use of an elementary application of Ohm's law. There are only two design precautions which must be kept in mind, and these are:

- (1) The voltage drop in the plate resistors G should be made equal to the voltage drop in the plate circuit of the input tubes, i.e., 150 volts; which means that the voltage applied to the high-potential side of the G resistor should be $2 \times 150 = 300$ volts. This voltage should appear at the junction of resistors E and F.
- (2) The bleeder current through resistor F should be exactly equal to the plate and screen-grid currents required by both input tubes, i.e., $(1.5 + .5) \times 2 = 4$ ma.

With these points in mind, it is extremely simple to calculate the values of all the resistors based on a voltage drop across, and current through, each one. The following tabulation indicates the formulas used:

RESISTOR	3			
B	$\frac{3V}{.004 \text{ ma}}$	= 750 ohms	=	$\frac{3V}{I_{c1}}$
F	$\frac{125}{2[2(1.5 + .5)] \text{ ma}}$	=	$\frac{125}{.008}$	= 15,600 ohms $\frac{1}{2W}$
E	$\frac{95}{2(1.5 + .5) \text{ ma}}$	=	$\frac{95}{.004}$	= 32,500 ohms $\frac{1}{4W}$
D	$\frac{95}{2(65 + 6.5) + 1 + 4 \text{ ma}}$	=	$\frac{95}{.148}$	= 640 ohms $\frac{1}{30W}$
C	$\frac{148 - 1}{150}$	=	$\frac{147}{147}$	= 505 ohms $\frac{1}{20W}$
G	$\frac{150}{.0015}$	=	100,000 ohms	

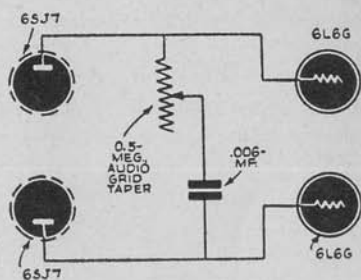

Fig. 44—Tone control circuit.

The wattage rating of each of these resistors should be between 2 and 3 times its actual watts dissipation, to provide a safety factor of 50 percent.

Figs. 40 and 41 are the complete basic circuit of the amplifier. The output transformer, volume control and tone control have been intentionally omitted, as there is a large number of possible variations in these elements, depending upon the final application of the amplifier. If a separate output transformer is used for each side of the circuit, and separate input signals are applied, *twin-channel amplification* is effected, making this unit admirably adapted for reproduction of sound in "auditory perspective."

For conventional push-pull operation, it is necessary to use a good push-pull output transformer, together with a twin .5-meg potentiometer, as illustrated in Fig. 42. In order to obtain push-pull operation of the input tubes, it is necessary to feed a push-pull signal into the input of the amplifier. This is obtained by removing one of the phono pickup or microphone leads from ground, and feeding in through a 2-wire shielded cable. Microphones and pickups are easily attainable for this type of cable connection.

If it is impossible to isolate one of the leads of the input signal from ground, or if a low-impedance (200- or 500-ohm) input device be connected to the amplifier, an input transformer must be connected to the input jack of Fig. 42. In order to attain high-fidelity reproduction with low hum level, this unit should be a high-quality unit with a high-permeability core, hum-balancing coil structure and adequate shielding, and should match the input device to the input of the amplifier (100,000 ohms, grid-to-grid).

To permit the use of a lower-priced output transformer with this amplifier, a special push-pull inverse feedback and compensating network circuit can be employed, as illustrated in Fig. 43. When playing records through this amplifier you may wish to cut the high-frequency response to reduce needle scratch. A variable tone control is shown in Fig. 44.

List of Parts

- | | |
|--|--|
| 1—Power transformer, 750 v, c.t. at 130 ma; 5 v at 2 amp; 6.3 v at 3 amp | 1—Resistor, 32,500 ohms, 1 w |
| 1—Filter choke, 10-20 h, 125 ma, 40-60 ohms | 1—Chassis |
| 2—Condensers, 10 μ f, 450 v | 2—6SJ7 tubes |
| 1—Condenser, 20 μ f, 450 v | 2—6L6 tubes (or 6L6-G) |
| 1—Condenser, 30 μ f, 450 v | 1—5V4-G tube |
| 2—Resistors, 2 meg, $\frac{1}{2}$ w | 1—Push-pull output transformer, primary 5,000 ohms, c.t. |
| 2—Resistors, .25 meg, $\frac{1}{2}$ w | 1—Dual shielded volume control, .5 meg |
| 2—Resistors, .5 meg, $\frac{1}{2}$ w | Resistors and condensers for inverse feedback circuit: |
| 2—Resistors, .1 meg, $\frac{1}{2}$ w | 2—Condensers, .003 μ f, 600 v |
| 1—Resistor, 15,600 ohms, 2 w | 2—Condensers, .006 μ f, 600 v |
| 1—Resistor, 750 ohms, $\frac{1}{2}$ w | 2—Resistors, 5,000 ohms, 1 w |
| 1—Resistor, 640 ohms, 30 w | 2—Resistors, 1 meg, $\frac{1}{2}$ w |
| 1—Resistor, 505 ohms, 20 w | |

Transformer-Coupled 6 L 6's

THIS AMPLIFIER was designed for the reproduction of musical programs with a high degree of realism. The amplifier had to be more than just ordinarily good, as its ultimate purpose was to please the discriminating music lover.

In the tube line-up, triodes are used, with the exception of the output stage which uses 6L6-G's in push-pull with inverse feedback.

High-fidelity audio transformers are used in input and output of the



Fig. 45—Appearance of the finished transformer-coupled amplifier.

6L6 stage and are largely responsible for the excellent results of which this amplifier is capable. These transformers have a frequency response of $\pm 1/2$ db from 30 to 15,000 cycles and have hum-bucking construction, with heavy iron cases. The overall gain of the amplifier is approximately 75 db. Power output is 15 watts with less than 2-percent distortion,

although higher output is possible with an increase in distortion content. High power output was not considered an essential factor during design; medium power output, with excellent fidelity, was the keynote. However, an output up to 15 watts provides an adequate reserve for the handling of loud signals without noticeable distortion.

The first audio stage is a 6J5, self-biased. To take advantage of the small amount of degeneration occurring in the 2,500-ohm bias resistor, there is no bypass condenser from cathode to ground. The grid of this stage receives its signal from the volume control which is connected to a phono-radio switch. A high-frequency tone control, consisting of a .02- μ f condenser and a 150,000-ohm potentiometer, is connected from plate to ground of the 6J5.

Direct coupling between the first audio stage and the phase inverter was made practical by adjusting the first audio stage's operating plate voltage to the proper voltage for the grid of the phase-inverter tube (100 volts). A study of the voltages in the phase-inverter diagram reveals that the plate supply for the first audio stage is 250 volts. This tube draws 1 ma plate current, causing a 150-volt drop in the combination of R2 and R3, developing an operating potential of 100 volts for its plate, and, by virtue of the direct coupling, the same potential for the grid of the phase-inverter tube. This voltage automatically biases the 6J5 phase-inverter tube to where its plate current is approximately 2 ma. This current causes a voltage drop of 102 volts across R4 and a similar drop across R5, leaving 158 volts as measured from plate to cathode of the phase-inverter tube. R2 is the first-stage plate resistor and R3 performs the dual function of filtering and dropping the voltage to the proper level at the point of the direct coupling, i.e., 100 volts.

The plate voltage supply for the phase-inverter tube was made high purposely, in order to avoid too low a potential on the plate of the first audio stage. The plate voltage of the first audio stage and the cathode voltage of the phase-inverter tube are practically the same, with the exception of a few volts of bias that are developed in the phase-inverter cathode resistor. This high voltage is taken from the output stage plate supply where 375 volts are available. Additional filtering was required at this point to keep all traces of hum out of the phase-inverter stage. This is adequately accomplished by CH1 and the 8- μ f condenser C2.

Care was exercised in selecting the phase-inverter cathode and plate resistors R4 and R5 to be certain of obtaining as near a match as possible between the two.

Following the phase inverter is a stage of push-pull 6J5's. Push-pull at this point was considered desirable for the elimination of second-harmonic distortion at high signal levels. Also, while the grids of the output stage are never driven positive, the use of feedback doubles the signal voltage required of the driver stage. A high-fidelity transformer couples this stage to the output stage.

The first audio stage and power supply are on the tuner chassis which is used with this amplifier for the reception of radio broadcasts. The tuner is not shown. The power supply is conventional, as can be seen in the schematic diagram. The phase-inverter, push-pull driver stage and push-pull output stage are on the chassis pictured in the

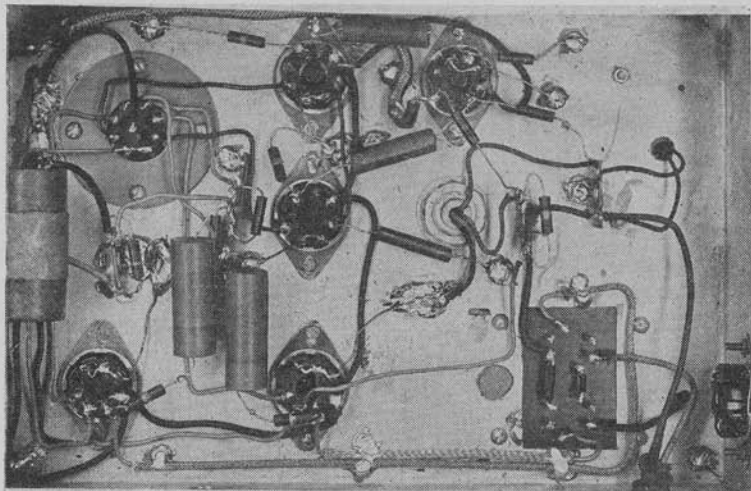

Fig. 47—Under-chassis view of the amplifier.

photo and are within the dotted line portion of the schematic diagram. Heavy stranded wire is used to connect the 6.3-volt heater winding to the amplifier. Each wire is connected to two pins on the plug to which it connects, and, correspondingly, two lugs on the plug socket are joined, to avoid the possibility of a voltage drop and consequent heating at this juncture.

List of Parts

R1—2,500-ohm, $\frac{1}{2}$ -w resistor
 R2, 4, 5—50,000-ohm, $\frac{1}{2}$ -w resistors
 R3, 11, 12, 13—.1-meg, $\frac{1}{2}$ -w resistors
 R6, 7—.5-meg, $\frac{1}{2}$ -w resistors
 R8—500-ohm, 1-w resistor
 R9, 10—20,000-ohm, $\frac{1}{2}$ -w resistors
 R14—25,000-ohm, 25-w adjust. w.w. resistor
 R15—200-ohm, 10-w adjust. w.w. resistor
 VC—2-meg potentiometer
 TC—.15-meg potentiometer
 C1, 2—8-8- μ f, 450-v elect. condensers
 C3, 4—.01- μ f, 600-v condensers
 C5, 6—.1- μ f, 600-v condensers
 C7—.1- μ f, 200-v condenser
 C8—18- μ f, 450-v elect. condenser
 C9, 10—30- μ f, 450-v elect. condensers

C11—50- μ f, 50-v elect. condenser
 C12—.02- μ f, 600-v condenser
 CH1—300-h, 5-ma choke
 CH2—5-h, 200-ma choke
 T1—High-fidelity a.f. input transformer, push-pull plates (20,000 ohms c.t.) to push-pull grids
 T2—High-fidelity output transformer, push-pull 6L6 plates (6,600 ohms c.t.) to voice-coil secondary (1.25 to 15 ohms tapped)
 T3—Power transformer, 800 v c.t. at 200 ma, 5 v at 4 amp, 6.3 v at 5 amp
 2—6L6-G tubes
 4—6J5 tubes
 1—5T4 tube

Wire-Recorder & Amplifier

USING PARTS lying around the workshop, any amateur, serviceman or experimenter can build this magnetic wire recorder and special audio amplifier-oscillator, to record voice and music on wire about the diameter of a human hair.

The amplifier used is a conventional circuit capable of 5 watts output with a few modifications and the addition of a low-frequency oscillator. The oscillator may be on a separate chassis if necessary. The recording head, which is also the reproducer, can be constructed from old audio transformer laminations which must be filed to fit the coil being used in the head. The coil can be found in old magnetic phonograph pickups or magnetic speakers.

The wire puller, the spool that winds the wire, is best powered by an old electric phonograph motor. The spools or reels on which the wire

Fig. 48—The complete set-up. The stroboscope is a permanent part of the apparatus.

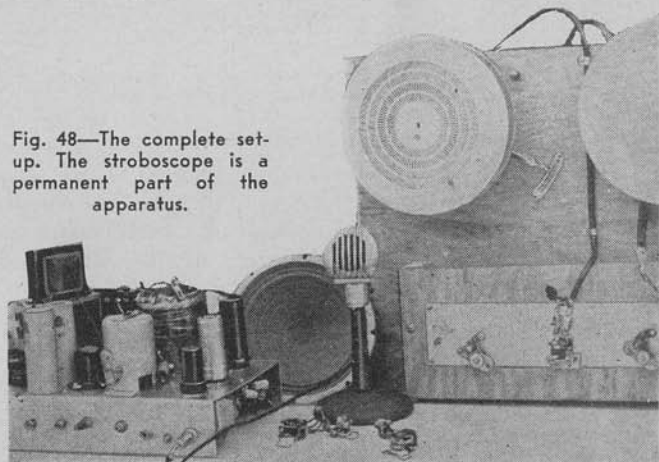

is wound can be cut out of solid wood or laminated boards. The wire guides should be of nonmagnetic material such as pulleys taken from old radio dial assemblies. These components may be mounted in any number of ways to suit the individual builder.

The wire used for recording must be a steel wire with .5- to .9-percent carbon content. Piano wire .014 inch in diameter and smaller can be used. The smaller the wire, the better the quality.

The audio amplifier is a four-stage resistance-coupled job using two 6SJ7's, a 6N7 and a 6L6. An 80 or 5Y3-GT is used for the rectifier. The amplifier differs from conventional ones only in the addition of an audio filter to attenuate the low frequencies when recording. The filter

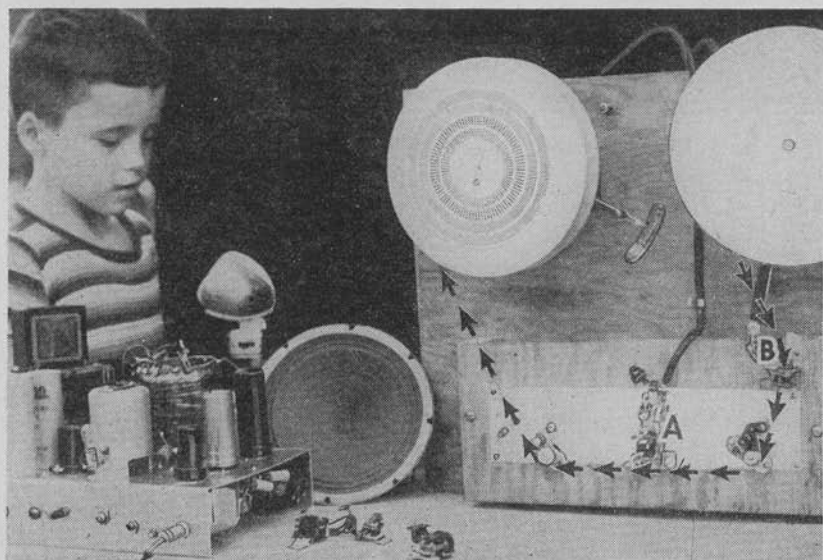

Fig. 49—Recording on the magnetic wire—arrows show the direction of the wire movement. A is recording head, B the erase coil.

consists of two resistance-capacity-inductance networks connected between the second and third stage of the amplifier. Fig. 50 shows the circuit. The first network consists of an $.006\text{-}\mu\text{f}$ condenser C8, shunting two series-connected 4,000-ohm resistors R9 and R10. Series-connected from ground to the junction of R9 and R10 are a 125-mh r.f. choke CH1; a 25,000-ohm variable resistor R24; and a single-pole single-throw switch S1. Circuit and parts values of the second network (C9, R11, R12, R25, CH2 and S2) are identical with the first.

The output of the amplifier is fed through a $.25\text{-}\mu\text{f}$ condenser C14 and a 6-pole selector switch S3, which connects to a pickup coil on the oscillator when recording. When playing back, the selector switch grounds the oscillator pickup coil and connects the output to the voice coil of the speaker. For recording, the magnetic pickup is connected across the oscillator pickup coil to ground. The magnetic recorder head is connected by a selector switch from the input to the output of the amplifier, depending on whether you are recording or reproducing.

The oscillator circuit is a conventional Hartley using a 6V6. The oscillator coil is wound on a form 3 inches in diameter and $3\frac{3}{4}$ inches long. The primary has 260 turns of No. 33 s.s.e. closely wound. The two

secondaries can be wound with No. 32 enamel wire (from an old speaker field coil). Tap the coil at 45 turns and then at every fifth turn up to 80 turns. The plate supply is fed into one of these taps. In the original model, the oscillator worked best connected to the third tap. At the terminations of the windings 2-56 screws are used as terminals. Apply a liberal coating of coil dope. After this dries, wind L2, the No. 1

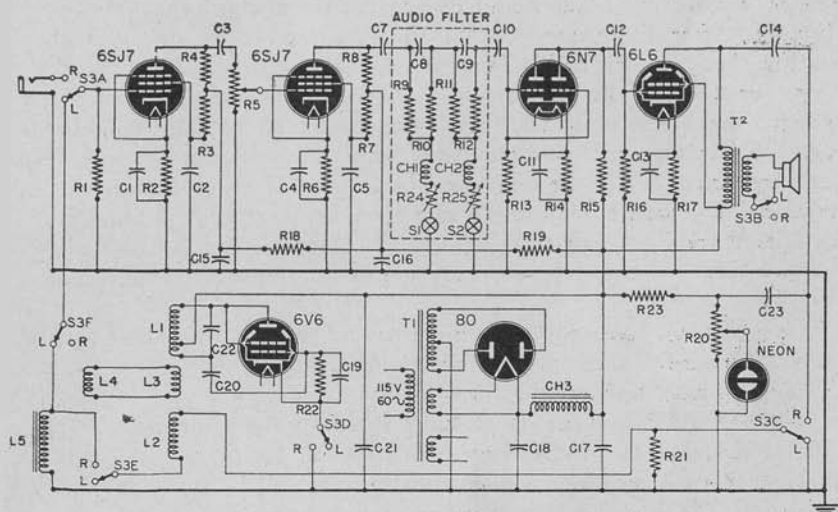

Fig. 50—Schematic of the oscillator-amplifier used with the recorder.

secondary. This is the coil used in the audio circuit in recording. This coil consists of 27 turns which are also brought to two 2-56 screws as terminals. After dopping this winding and allowing it to dry, wind the second secondary L3, which has 120 turns terminated in the same manner as the previous windings. This second secondary is the pickup coil for the *erase* coil.

The oscillator is tuned with an .01- μ f mica condenser and should produce a signal between 27 and 30 kc. The action of this supersonic frequency added to the signal current is not well understood but it is essential to good recording.

As previously stated, when recording, the output of the amplifier is fed through the oscillator coil L2 to the recording head L5 and then to ground. The selector switch opens the oscillator cathode connection to ground when the machine is used to play back or reproduce.

The next step is the construction and selection of parts for the recording head. Here each individual must use his imagination and ingenuity. We have constructed about 12 heads. Each one used a coil different in either physical size, shape, number of turns, or d.c. resistance. Therefore we will describe the construction of only one, the one that has worked best.

The coil used came from an old discarded magnetic speaker, the d.c. resistance measuring 700 ohms. The physical dimensions were $\frac{3}{4}$ by $\frac{25}{32}$ by $\frac{1}{2}$ inch. The core was $\frac{3}{16}$ by $\frac{5}{16}$. Refer to Fig. 51 for the shape and manner of assembling. Almost any coil will work as long as the gap in the core is kept between .001 to .003 inch. Use a piece of brass shim stock to maintain the gap at .002. Use a jeweler's hack saw with the finest blade obtainable to cut the slot for the wire to run through. After filing the core to shape, assemble the pieces without putting them on the coil. Clamp them together to permit drilling the holes for 2-56 screws. Then string the pieces on a wire, being careful to observe the order in which they were assembled so they may be re-assembled in the exact way they were when the holes were drilled. With the wire strung out so the individual laminations are well separated, heat them red hot with a blow torch and then let them cool gradually. We also have tried cooling them in an a.c. magnetic field—using an old speaker field for the purpose. This seemed to improve the efficiency of the core.

After cooling, assemble the laminations on the coil. Hold this together with 2-56 screws and nuts. Before tightening, dip the whole thing in dipping varnish, tighten and allow to dry.

Next get a small piece of phenolic tubing $\frac{1}{8}$ -inch diameter or some similar material, to wind the erase coil I4 on. The wire will be passed through this coil to clean it magnetically so it will be ready for another recording. We used No. 28 enamel wire, but the size or number of turns should not be critical. The tubing was about $1\frac{1}{2}$ inches long and the coil on the tube about 1 inch long, layer-wound about 200 turns. Mount this between two pieces of $\frac{1}{4}$ -inch bakelite with holes drilled for a close fit so the tubing fits into the holes in the bakelite ends. Cement the coil in place with ordinary coil cement.

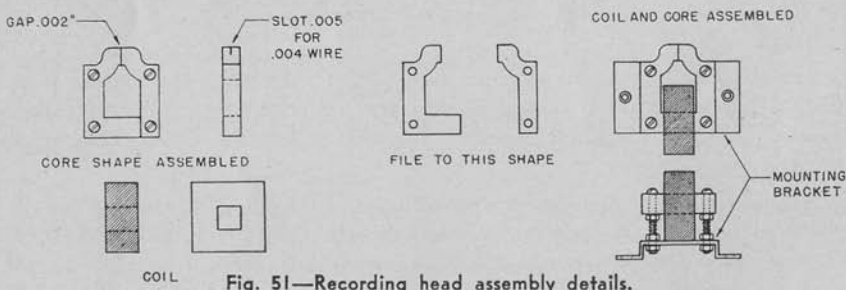

Fig. 51—Recording head assembly details.

We are now ready to assemble the wire puller, head and erase coil. We mounted the motor below the panel with an extension on the drive shaft. The two wire-pulling drums used were about 5 inches in diameter with a rim on each side to keep the wire from running off. Use microphone cable to connect the recording head and erase coil to the amplifier-oscillator assembly. A word of caution here in regard to running the

wire puller: use your hand as a brake when stopping the reels! The wire may become hopelessly snarled if the reels are allowed to coast after the power is turned off. Rewind the wire by hand. Incidentally, when recording or reproducing, the wire should move through the head at a constant speed of about 180 feet per minute. Whatever your speed is (it will work at slower speeds but not as well), it must be constant all the time.

Adjustment of controls when recording

You will have to find by trial and error how high to run the volume control when recording. Each set will vary, of course. The audio filter is used only when recording, the switches being opened when playing back. The setting of the controls when recording is found by experiment. If the reproduction sounds too bassy and garbled, it indicates you haven't filtered out the low frequencies enough; it will be necessary to set the controls for less resistance in the circuit when recording. By connecting a pair of earphones across a small coil similar to the one used in the recording head and holding it close to the recording head you can monitor the record continuously.

Before you have taken the "bugs" out you will have broken your recording wire many times, unless you're exceptionally fortunate—and we've never yet met a radioman that lucky. So remember this suggestion: When the wire breaks, anneal the ends with a match flame, the heat from a cigaret, or bring out a tap from a filament supply and hold the wire across the supply until it changes color. Then tie the ends together with a square knot and cut the surplus ends off. Apply a little more heat after tying the wire. The very small steel wire will burn if a match is held too close to it, so be reasonably careful.

A neon bulb is used as a volume level indicator as shown on the schematic. The point at which this bulb will flash can be controlled by R20. It should be adjusted so the bulb flashes only on the amplitude peaks.

List of Parts

R1, 3—2-meg resistors
R2—1,500-ohm resistor
R4, 23—500,000-ohm resistors
R5—500,000-ohm potentiometer
R6—1,000-ohm resistor
R7—1-meg resistor
R8, 13—250,000-ohm resistors
R9, 10, 11, 12—4,000-ohm resistors
R14—1,500-ohm resistor
R15—100,000-ohm resistor
R16—250,000-ohm resistor
R17—200-ohm, 10-w resistor
R18, 19—30,000-ohm resistors
R20—100,000-ohm potentiometer
R21—20,000-ohm, 10-w resistor
R22—25,000-ohm resistor
R24, 25—25,000-ohm potentiometers
(All resistors $\frac{1}{2}$ w unless otherwise stated)
C1, 4, 11, 13—20- μ f, 50-v cond.
C2, 3, 5, 12, 21—.06- μ f, 600-v cond.

C7, 10, 14—.25- μ f, 600-v cond.
C8, 9—.006- μ f, 600-v cond.
C15, 16—8- μ f, 450-v cond.
C17, 18—30- μ f, 450-v cond.
C19—.0005- μ f mica cond.
C20, 22—.01- μ f, mica cond.
C23—.03- μ f, 600-v cond.
CH1, 2—125-mh r.f. chokes
CH3—10-20h, 120-ma filter choke
L1—Oscillator coil
L2—No. 1 secondary
L3—No. 2 secondary
L4—Erase coil
L5—Recording and reproducing head
S1, S2—Single-pole single-throw switches
S3—6-pole double-throw switch
T1—Power transformer, 600 v, c.t., 120 ma;
6.3 v, 3 amp; 5 v, 2 amp
T2—Output transformer, 4,500 ohms pri.
to voice coil.

DUAL HIGH-FIDELITY SYSTEM

THIS AMPLIFIER may be used as a conventional audio amplifier, using either of its three input circuits or two output circuits together, singly, or in any desired combinations. Two high-impedance inputs and one universal input make it possible to connect the amplifier to just about any type gear available. The mixing is *high-level electronic mixing*—it is accomplished after the signals have gone through one audio

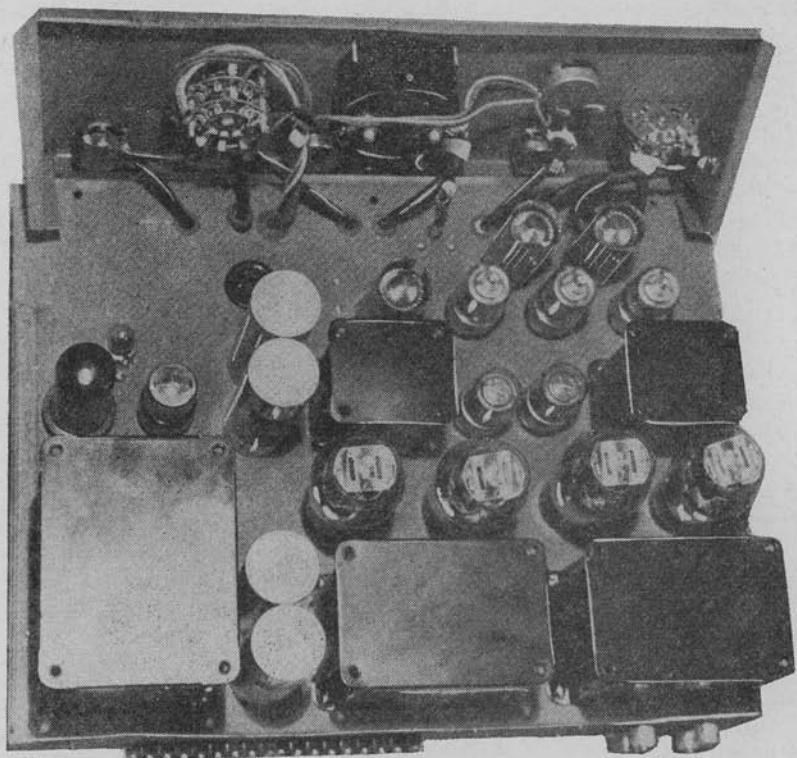

Fig. 52—Top view of the dual high-fidelity amplifier.

stage. The advantage of this method is that when the volume is controlled at a high-level point in the circuit there is less tendency for noise to develop. Normal output from either channel is 15 watts. Channels may be paralleled to give an undistorted output of 30 watts. Since the three input circuits may be mixed, an unlimited number of effects is possible.

As a recording amplifier one channel may be used for monitoring and one for recording. This prevents disturbance of the reflected load to the output stage. Output taps are available on the back terminal strip from 4 ohms to 500 ohms. This immediately introduces the possibility of using the amplifier as a cathode modulator, or as a speech amplifier in a medium- or high-power transmitter.

Tube line-up

The amplifier line-up consists of 14 tubes and one neon bulb, arranged as indicated in the block diagram (Fig 54-c). For obvious reasons it is not practical to attempt to place tubes in any specific order, since they are all related to one another and in many cases in identical manner. Tubes used are 3-6SJ7; 3-6J7; 2-6C5; 4-6A5-G; 1-6H6 and 1-5T4 (6A3's or 6B4-G's can be used instead of 6A5-G's with no circuit changes). The 6SJ7 and 6J7 have only 5 volts on the filament despite ratings of 6.3 volts. The reason for this is reduction of hum and shot effect (hiss due to electrons breaking loose from the cathode) and the minimizing of thermal agitation. The 6C5's are used as voltage amplifiers before the final stage. The 6A5-G's serve as the two separate output stages. The 6H6 is the rectifier for the bias supply, the two diodes being placed in parallel and the neon bulb serving as bias-voltage regulator. The 5T4 is the rectifier for the entire amplifier.

To simplify to some degree construction of the amplifier a full description of the controls is in order. The accompanying diagram may be used as reference chart (Fig. 54-b).

Control 1 is the range selector for the volume indicator. This indicator is calibrated in decibels using 6 milliwatts as 0 db. In order to increase the effective range of this scale an attenuator is inserted in series with the meter. Actually the meter is nothing more than a reference indicator, but as such is invaluable for audio work. After determining correct levels with the db meter, it may be continually referred to as a check for correct levels. Its most important use is in recording to prevent overcutting and undercutting, and in connection with this phase of the amplifier's operation is an absolute essential.

When the amplifier is used as a speech amplifier in a transmitter, the db meter is useful primarily to supplement the class B plate meter, which is the normal modulation indicator. The db meter may be calibrated against the class B plate milliammeter or better yet against an oscilloscope. This operation is quite simple. A calibration chart is drawn up

showing at what point on the meter 100-percent modulation is shown on the scope. These percentages may be recorded from 0 to 100 in whatever steps the operator desires, although 0, 25, and 100 should be ample.

The meter also will serve as an indicator of popular response at a party, or in amateur contests at various clubs, etc. It is often referred to as an *applause meter*, and while relatively unimportant the availability of the gadget should not be overlooked.

Control 2, as indicated on the diagram, is the output switch. Position 1

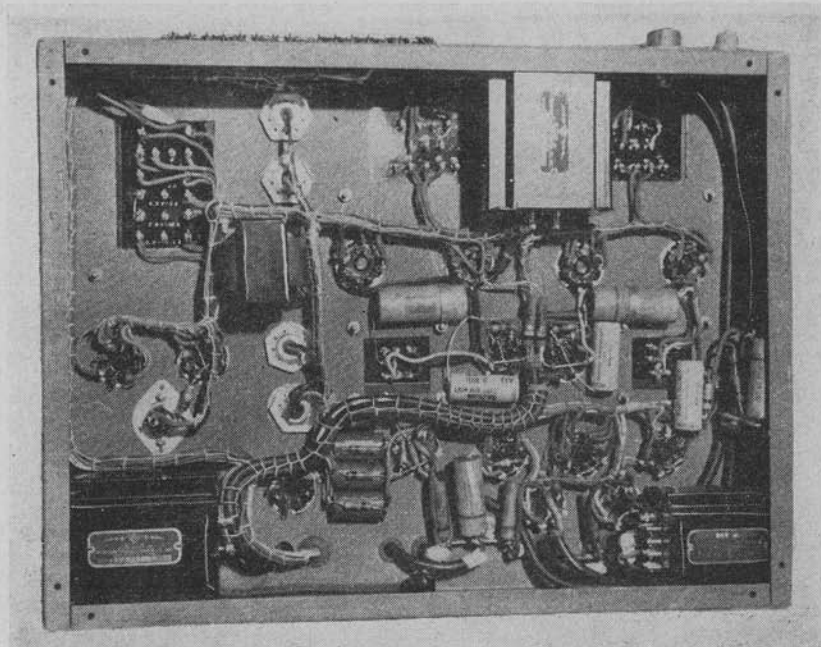

Fig. 53—Under-chassis view. Cabled wiring used in original model is not essential.

connects the two output stages in parallel to give a maximum audio output of 30 watts into an 8-ohm load. Position 2 switches a monitor speaker to channel 2 and connects the recorder to output channel 1. Position 3 connects the monitor speaker to channel 2, as in the case of Position 2, but switches a second recorder, if used, to channel 1. The purpose of this rather elaborate set-up is to permit continuous recording with dual turntables. The builder may, of course, select any switch set-up to suit his needs, provided the impedances are available on the transformer.

Control 3 affects only input channel 1. It was found desirable to obtain more flexibility in matching input impedances in at least one channel. Commercial microphones and some high-quality pickups, as well as the output of some tuners, are low impedance. Its first position connects the first grid to a chassis connector on the rear of the amplifier.

Position 2 connects the grid to the secondary winding of a hum-shielded line-to-grid transformer. This position is used to match low-impedance devices to the amplifier. This is in direct contrast to the high impedance available when the switch is on the first position. Position 3 connects this transformer to the grid of channel 1 through a fixed pad. In this position the channel may be used to amplify the output of a telephone line, high-output low-impedance pickup, or any other low-impedance high-level source.

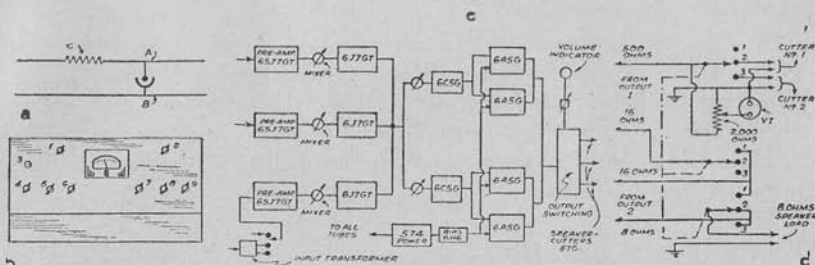

Fig. 54—*a*—Circuit of the voltage-regulator bulb. *b*—Front-panel layout. *c*—Block diagram. *d*—Output-switching circuits to cutting-heads and loudspeaker, showing volume indicator.

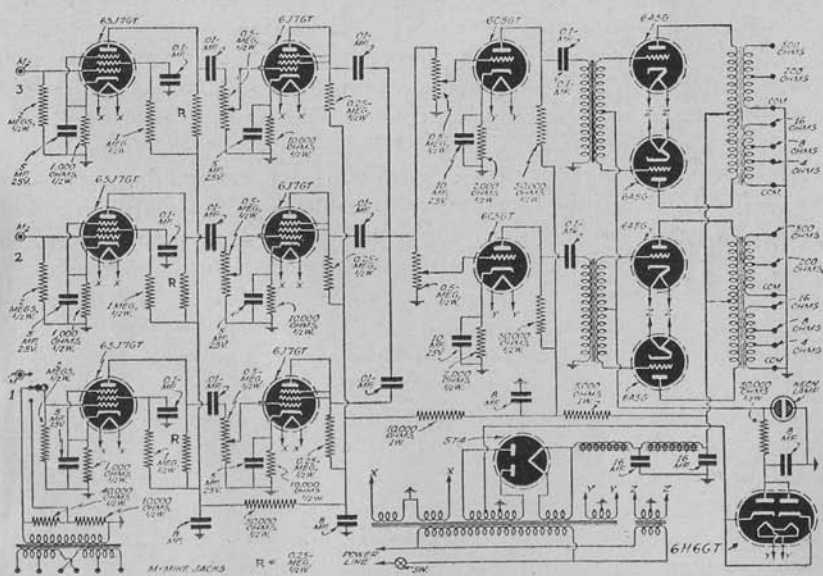

Fig. 55—Schematic diagram of the amplifier.

Control 4 is the volume control for input channel 1. Controls 5 and 6 are volume controls for input channels 2 and 3, respectively. Control 7 is the power switch. Controls 8 and 9 are volume controls for output channels 1 and 2.

The neon bulb is used as a voltage regulator because of its ability to change its resistance, depending upon the voltage drop across it. The circuit is extremely simple as Fig. 54-a illustrates. The theory behind it is that the neon bulb draws an initial load. A higher voltage across A and B will cause the neon bulb to draw higher current, thus causing a greater drop across C. A lower voltage will increase the resistance and consequently cause a corresponding decrease in voltage drop across C. Regulation is not perfect, but it is better than the regulation available when using a small tube like the 6H6, with a high-resistance filter. At no time is regulation poor enough to require an elaborate voltage regulation system using VR regulators, or a heavy duty bias supply.

Condenser input is used for the rectifier circuit to obtain a voltage high enough to be usable as bias. No condenser is necessary at the output of the bias supply, because of the tendency of the neon bulb to oppose changes in voltage.

Transformer details

The audio transformers used in this amplifier are high-fidelity units with shielded cases and electrostatic shielding between windings to reduce hum pickup. The input transformer is designed to match a multiple line to a 50,000-ohm grid circuit. The driver transformers have a 3:1 ratio (pri. to $\frac{1}{2}$ sec.). The power transformer supplies 360 volts each side of center tap and has one side tapped at 150 volts for the bias supply. Two 2.5-volt windings are connected in series to provide 5 volts for the filaments of the 6J7's and 6SJ7's.

The transformers (both power and audio) are the limiting factors in the amount and quality of output obtainable from the amplifier. They should be carefully selected if high quality and maximum undistorted output is the goal. A cheap power transformer may have poor regulation causing plate voltage to drop when volume level is raised. This of course will reduce the undistorted output rating of the amplifier. For the same reason, the two filter chokes should have as low d.c. resistance as possible. A cheap output transformer may have poor efficiency, particularly at high and low frequencies. There's no economy in spending time and money on a PA amplifier only to throttle it with a cheap output transformer.

Needless to say a good common ground throughout the entire unit is essential. To obtain low grid-to-ground capacity, crystal microphone cable was used for all grid leads. In order to obtain a somewhat neater job of wiring, spare prongs on tube sockets were used as mounting lugs.